



TECHNICAL DATA

GARAGE DOORS

05	R30 - UM
06	R40 - SM
07	R40 - UM
08	R40 - TM
09	R60 - SM
10	R60 - UM
11	R60 - TM
12	TL40 LHR - FM
13	TL40 LHR - RM
14	TL40 STD
15	TL60 LHR - FM
16	TL60 LHR - RM
17	TL60 STD
18	OPTIONS TO REDUCE HEADROOM AND INCREASE DAYLIGHT OPENING
19	TL40 LHR - FM PR
20	TL40 LHR - RM PR
21	TL40 STD PR
22	DOOR SIZE, PITCH ANGLE AND REQUIRED HEADROOM CORRELATION
23	SIDE SLIDING SECTIONAL DOORS SSD
25	PANEL TYPES
30	REINFORCEMENT PROFILES ON SANDWICH PANELS
31	ALU-FRAMED PANEL TYPES
32	RETRO
35	STAINLESS STEEL DECOR ELEMENTS OPTIONS
37	STAINLESS STEEL WINDOWS
38	PVC WINDOWS
41	WICKET DOORS
45	SIDE HINGED DOORS SH1
48	SIDE HINGED DOORS SH2
51	ALUMINIUM INSULATED DOORS SH2 THERMO

CONTENTS

TRACKS

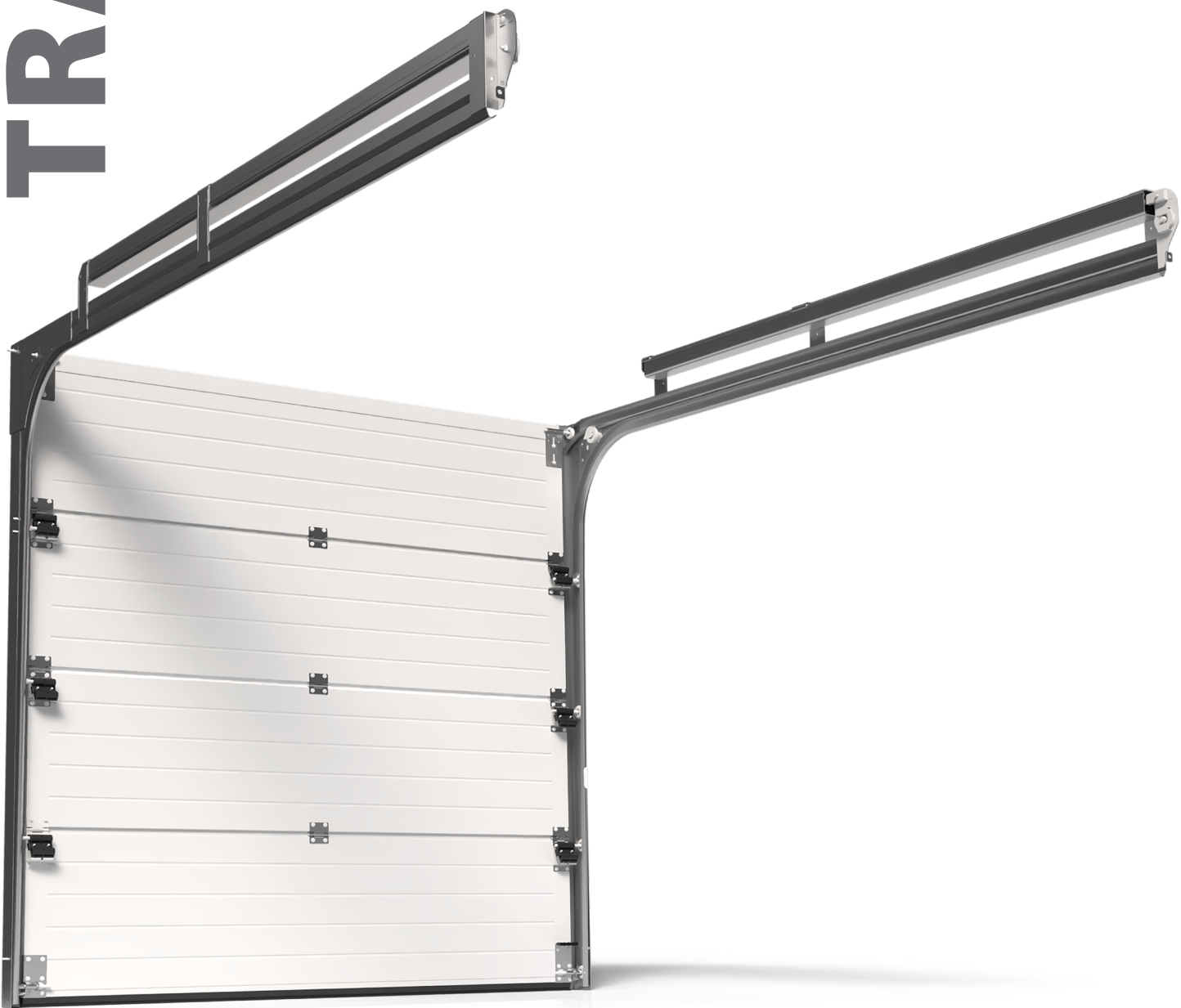

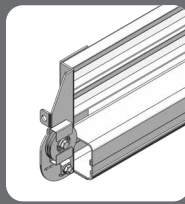

R30 - UM



h (headroom)	110 (manual) 150 (with el. operator)
SL / SR (sideroom)	80
Daylight opening	H - 30 (with el. operator)

H	D
≤ 2070	2680
2071 - 2125	2880
2451 - 2500	3007

Number of required suspensions	
W ≤ 3000	1 suspension per side

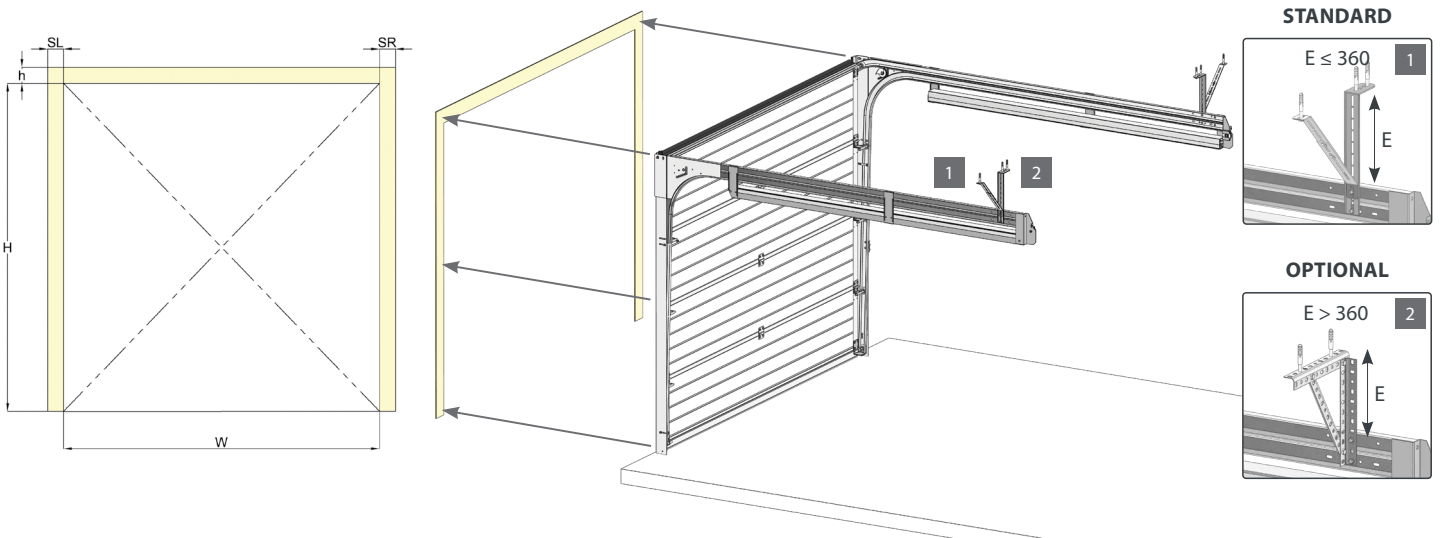
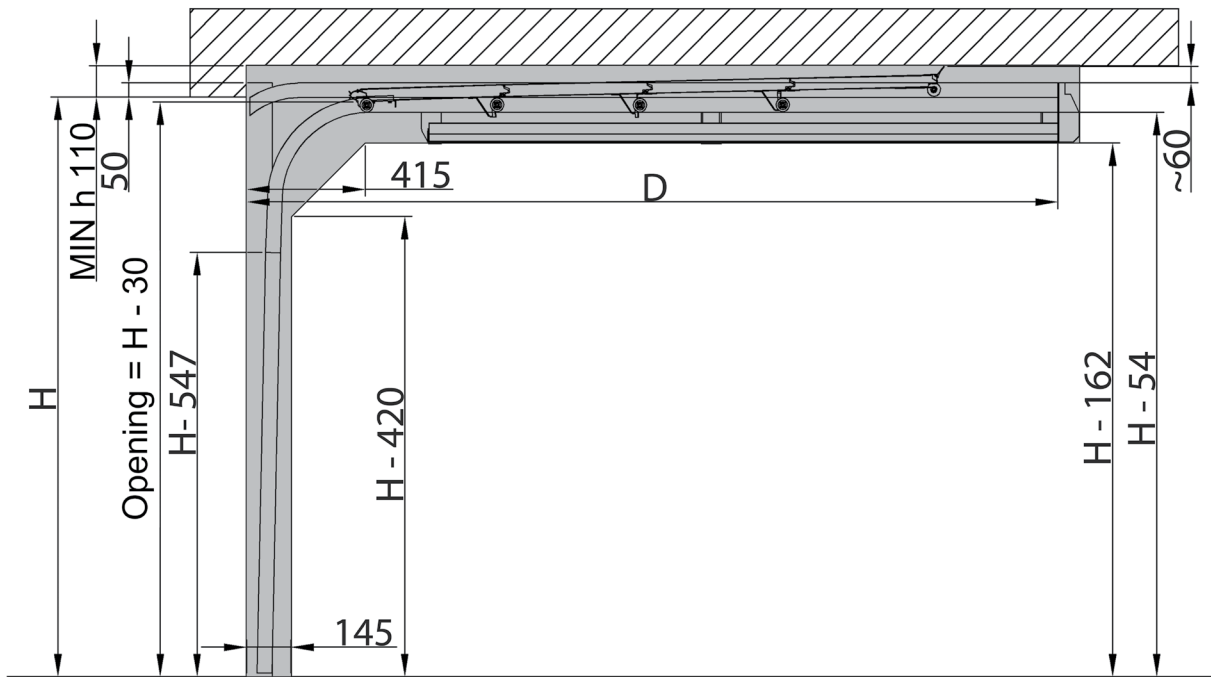
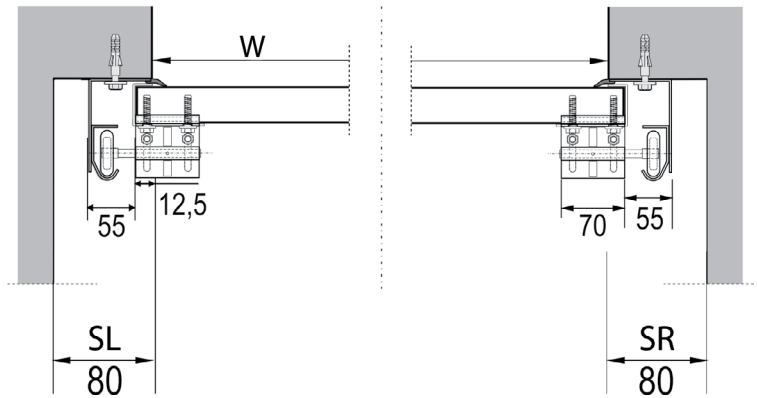

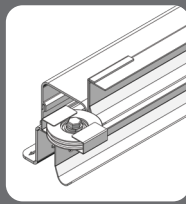

h (headroom)	110 (manual) 150 (with el. operator)
SL / SR (sideroom)	150
Daylight opening	H - 30 (with el. operator)

H	D
≤ 2070	2720
2071 - 2270	2920
2271 - 2400	3047
2401 - 2500	3300

Number of required suspensions	
W ≤ 3000	1 suspension per side
W > 3000	2 suspensions per side

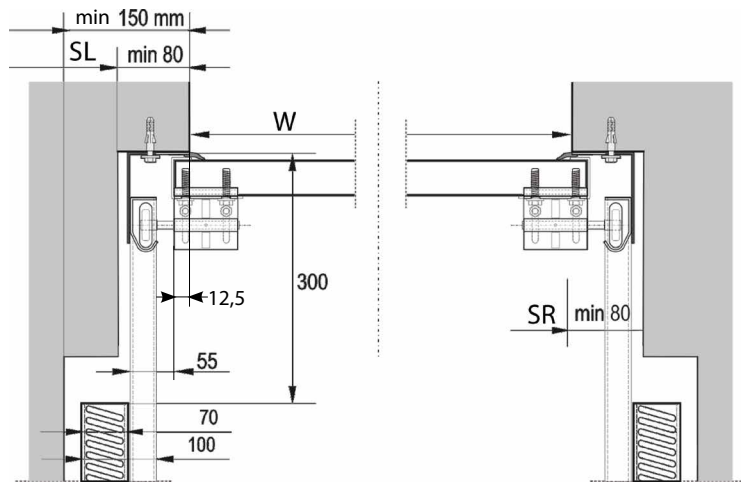

See page 18 for options to reduce required headroom and increase daylight opening.

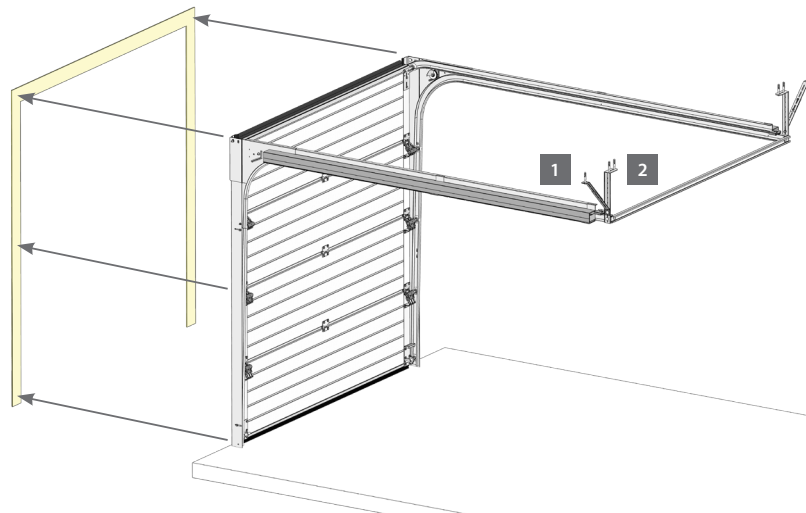
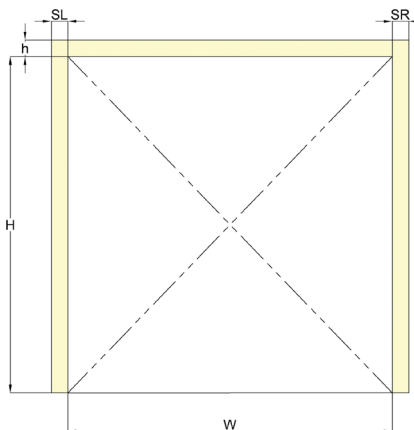
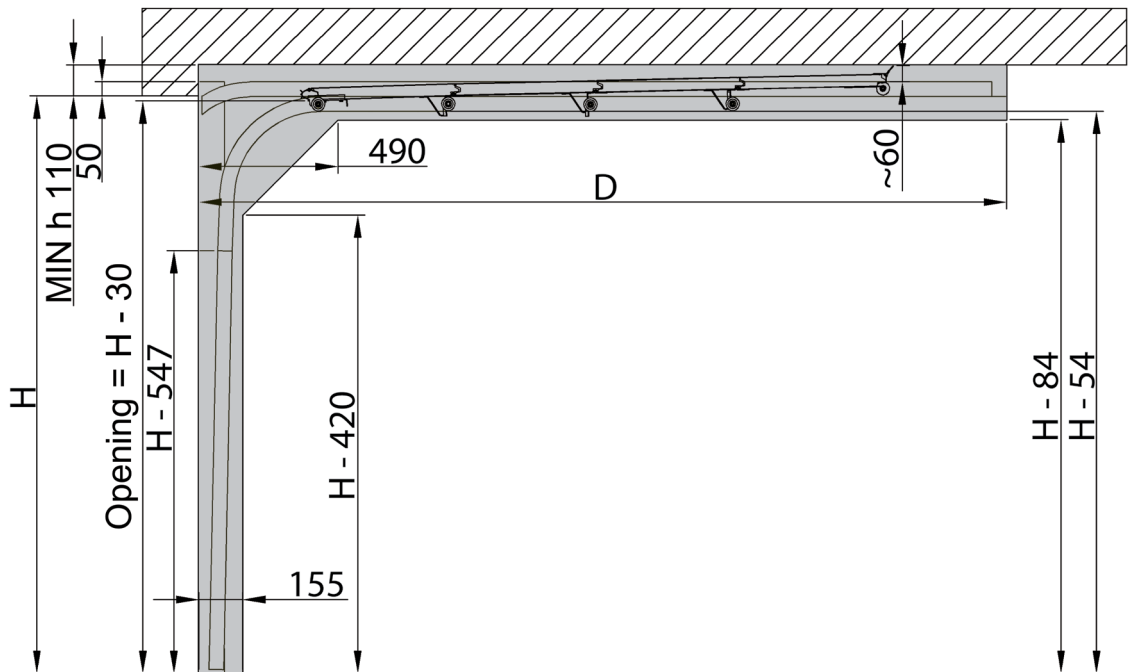

STANDARD

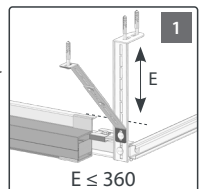

OPTIONAL

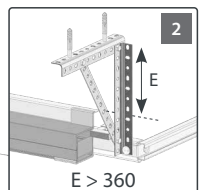

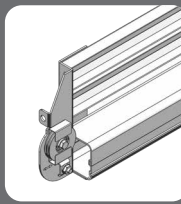

R40 - UM



h (headroom)	110 (manual) 150 (with el. operator)
SL / SR (sideroom)	80
Daylight opening	H - 30 (with el. operator)

H	D
≤ 2070	2680
2071 - 2270	2880
2271 - 2400	3007
2401 - 2500	3260

Number of required suspensions	
W ≤ 3000	1 suspension per side
W > 3000	2 suspensions per side

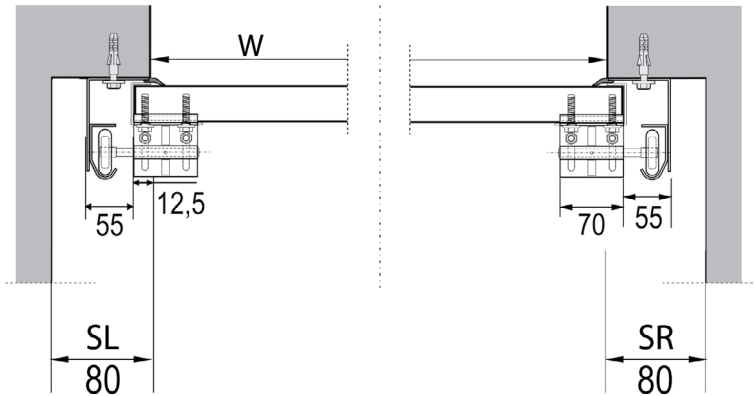

See page 18 for options to reduce required headroom and increase daylight opening.

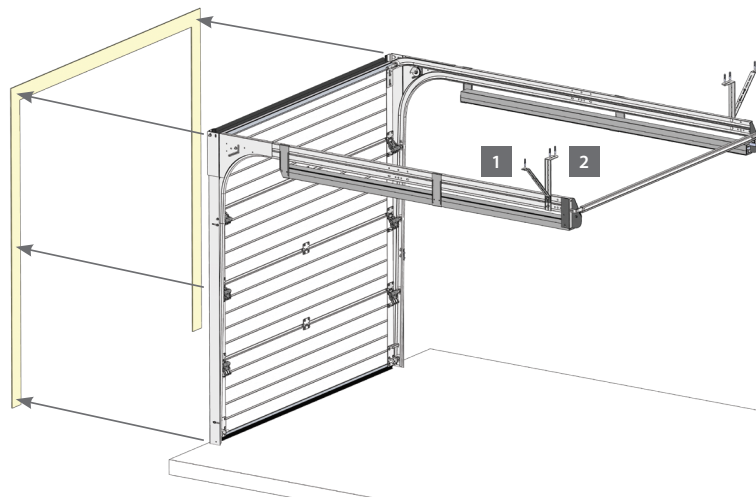
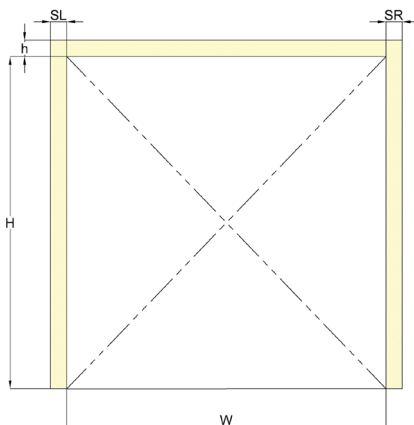
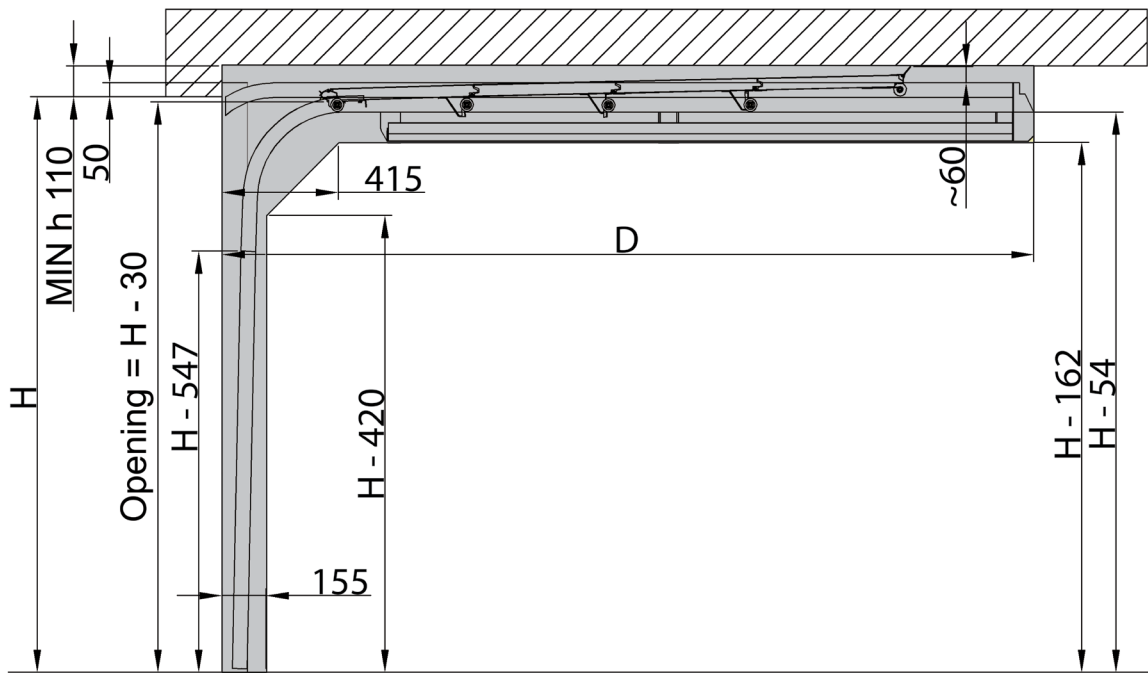

STANDARD

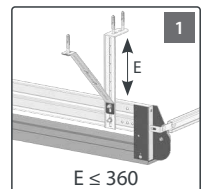

OPTIONAL

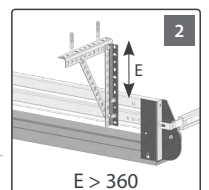

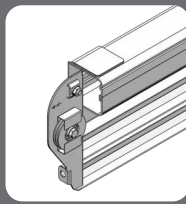

h (headroom)	180 (with el. operator or manual)
SL / SR (sideroom)	80
Daylight opening	H - 30 (with el. operator)

H	D
≤ 2125	2880
2126 - 2250	3007
2251 - 2500	3260

Number of required suspensions	
W ≤ 3000	1 suspension per side
W > 3000	2 suspensions per side

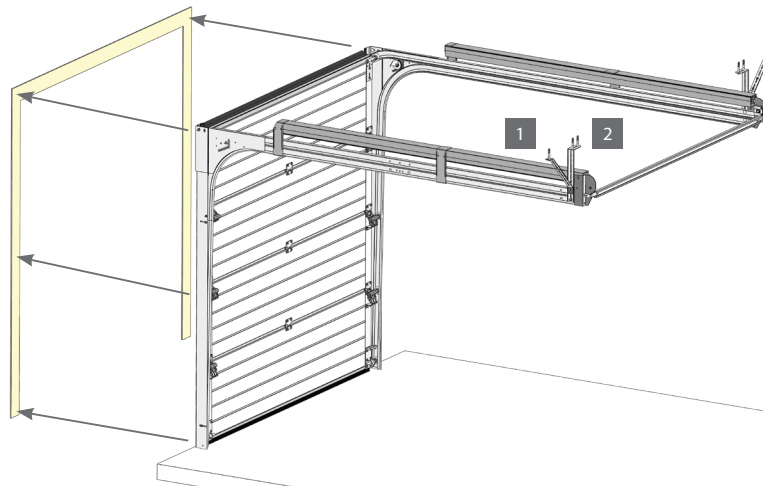
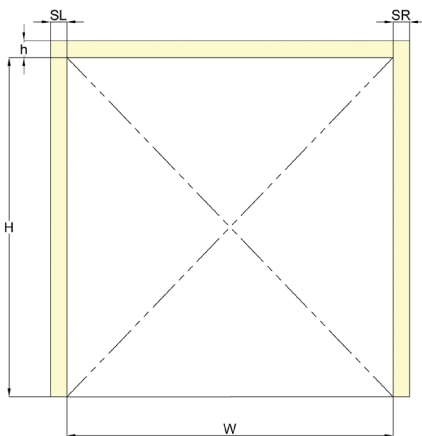
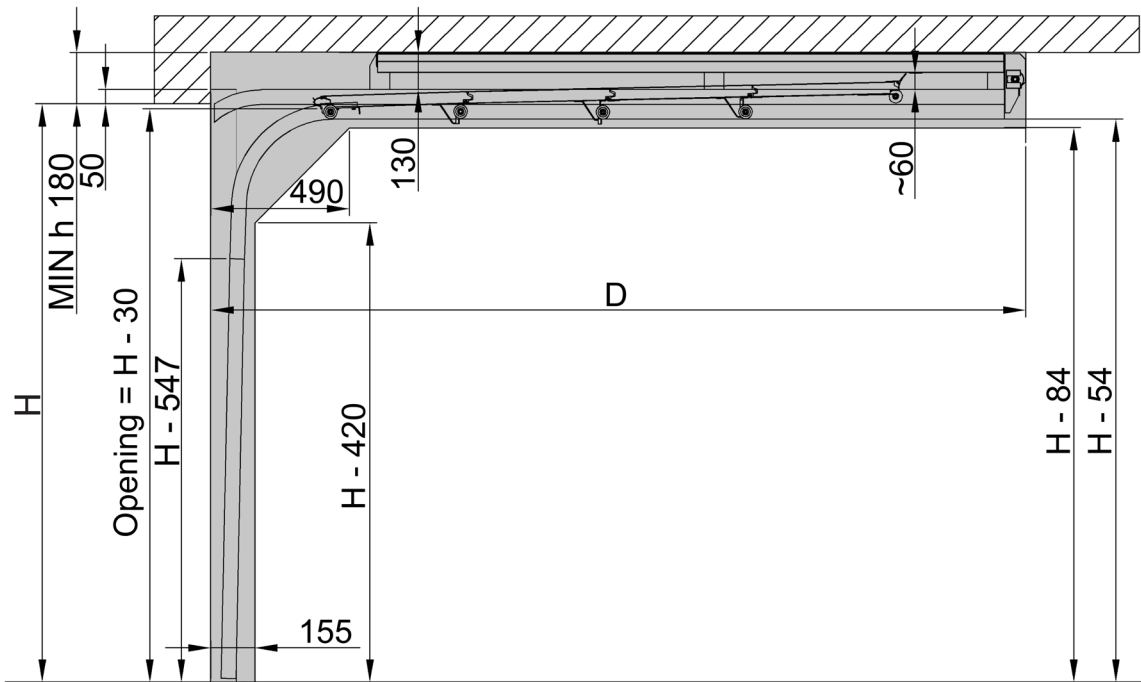
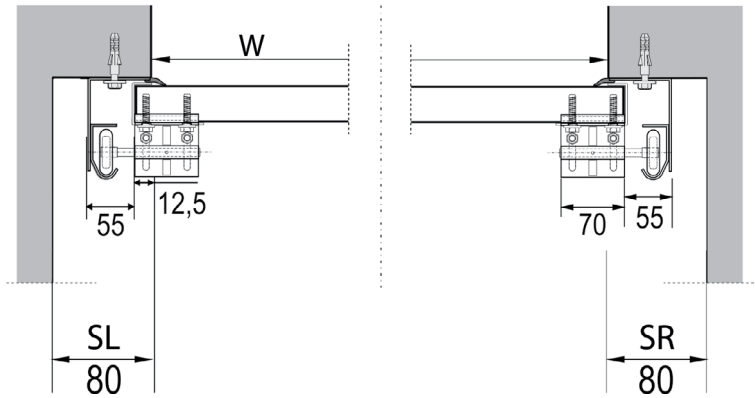

STANDARD

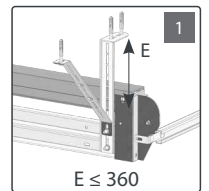

OPTIONAL

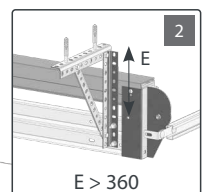

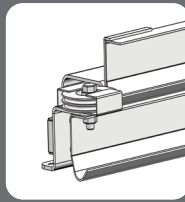

R60 - SM



h (headroom)	130 (manual) 170 (with el. operator)
SL / SR (sideroom)	80
Daylight opening	H - 30 (with el. operator)

H	D
≤ 2070	2720
2071 - 2270	2920
2271 - 2400	3047
2401 - 2500	3300

Number of required suspensions	
W ≤ 3000	1 suspension per side
W > 3000	2 suspensions per side

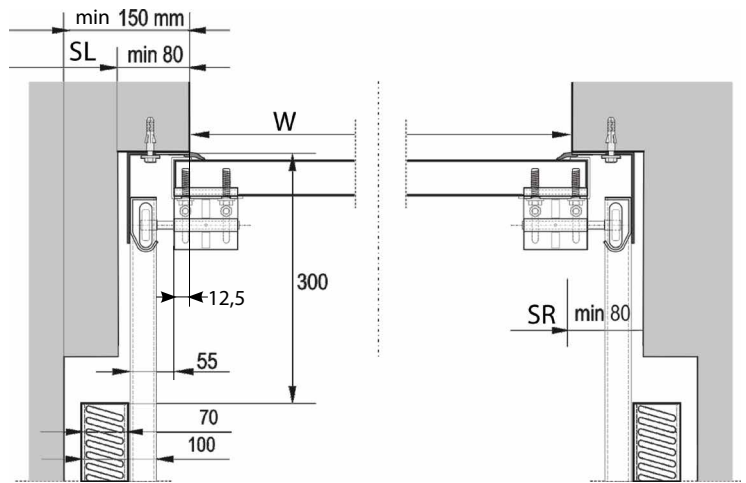

See page 18 for options to reduce required headroom and increase daylight opening.

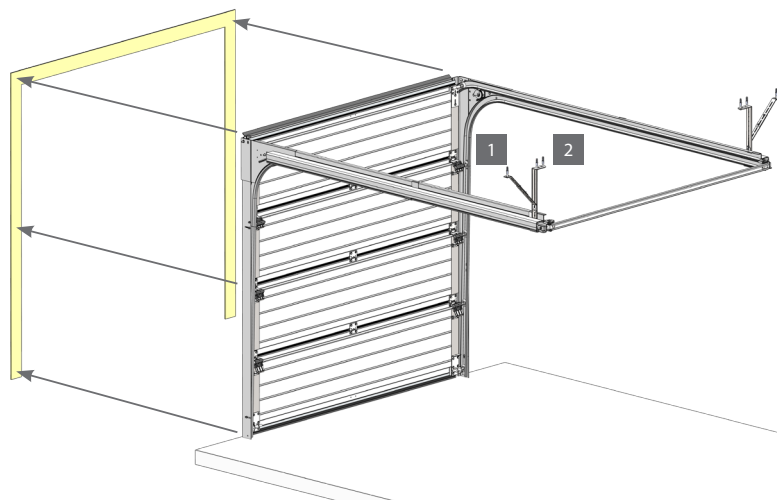
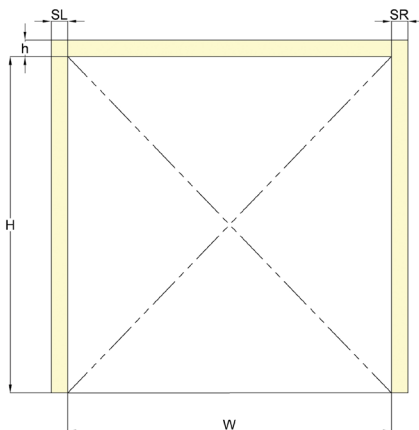
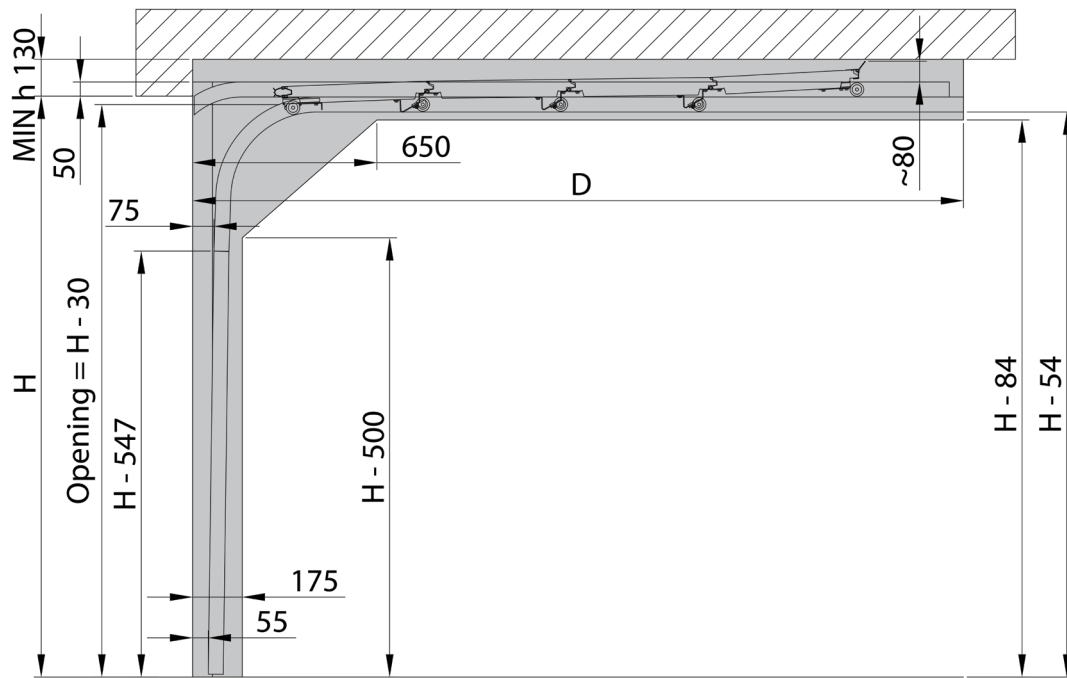

STANDARD

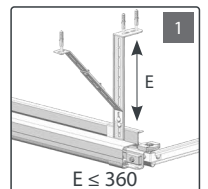

OPTIONAL

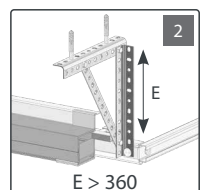

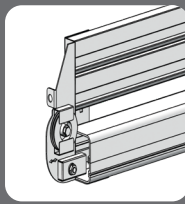

h (headroom)	130 (manual) 170 (with el. operator)
SL / SR (sideroom)	80
Daylight opening	H - 30 (with el. operator)

H	D
≤ 2070	2680
2071 - 2270	2880
2271 - 2400	3007
2401 - 2500	3260

Number of required suspensions	
W ≤ 3000	1 suspension per side
W > 3000	2 suspensions per side

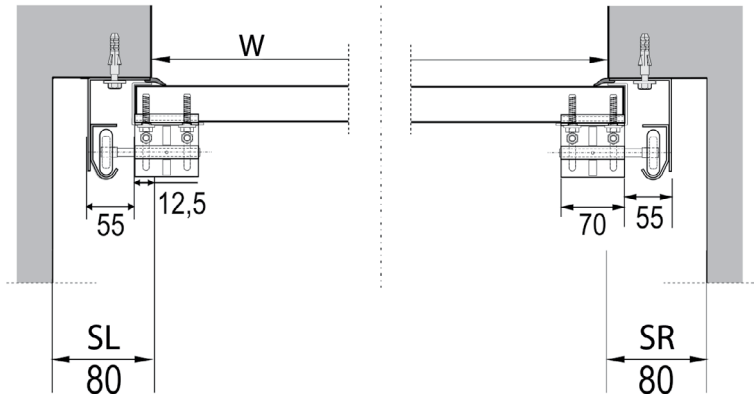

See page 18 for options to reduce required headroom and increase daylight opening.

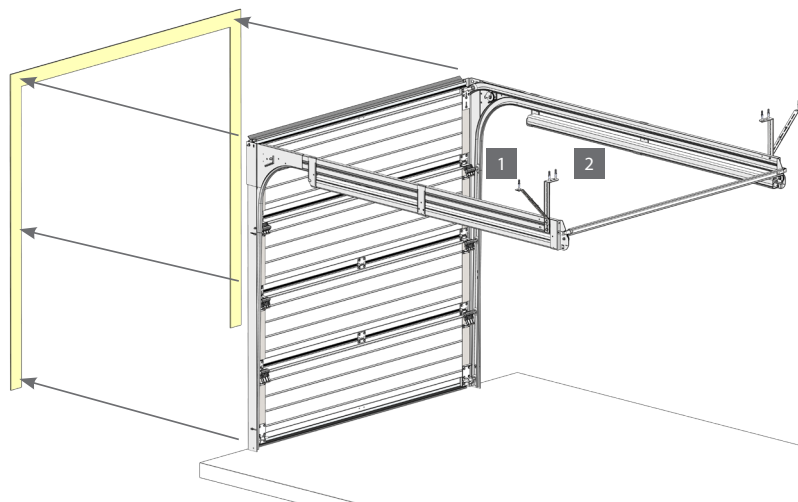
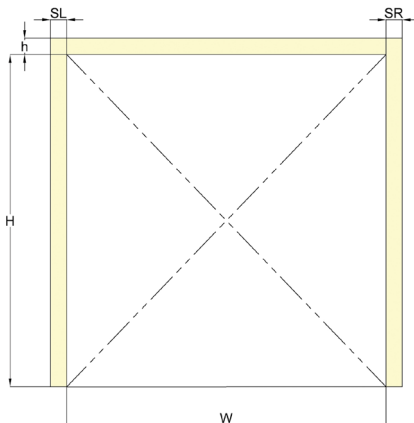
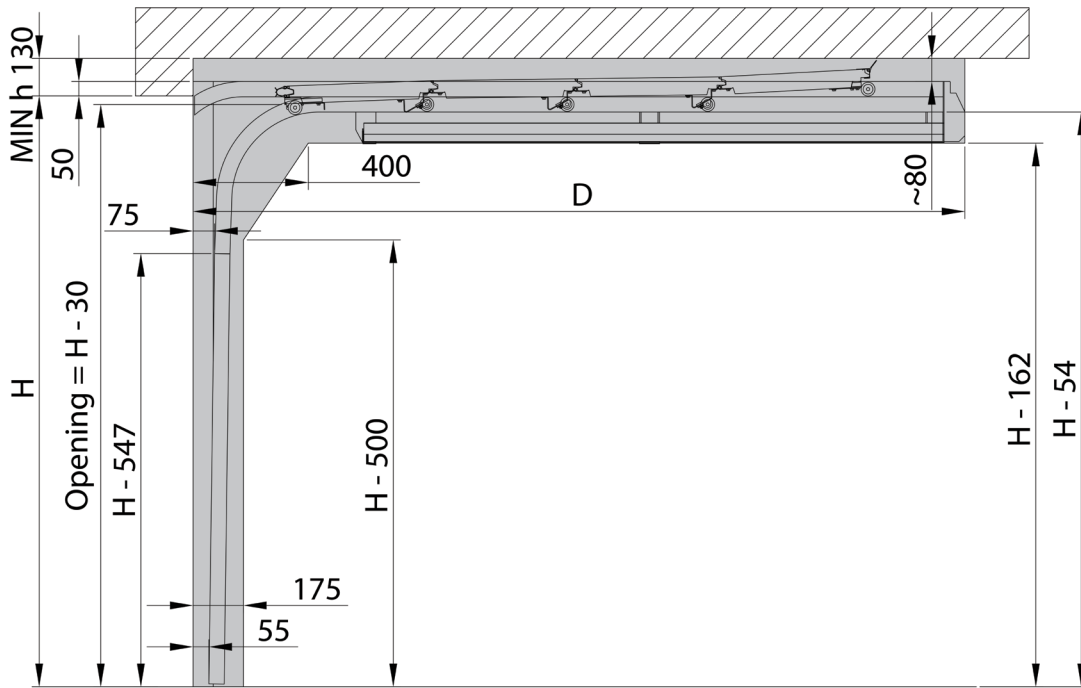

STANDARD

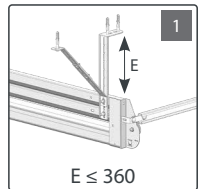

OPTIONAL

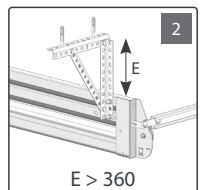

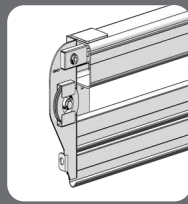

R60 - TM



h (headroom)	180 (with el. operator or manual)
SL / SR (sideroom)	80
Daylight opening	H - 30 (with el. operator)

H	D
≤ 2125	2880
2126 - 2250	3007
2251 - 2500	3260

Number of required suspensions	
W ≤ 3000	1 suspension per side
W > 3000	2 suspensions per side

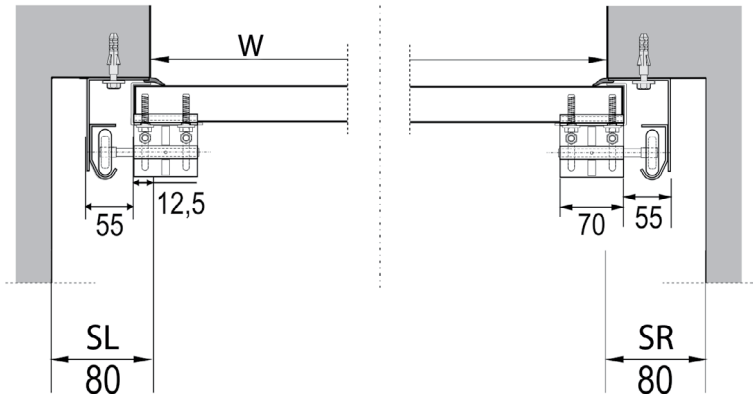

See page 18 for options to reduce required headroom and increase daylight opening.

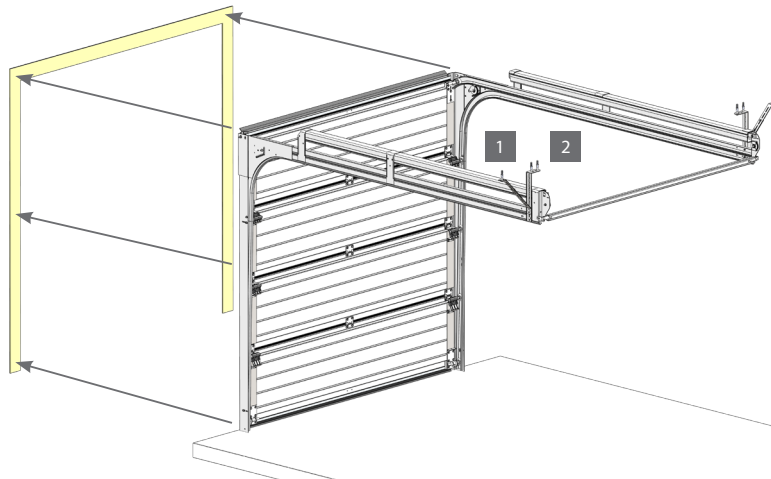
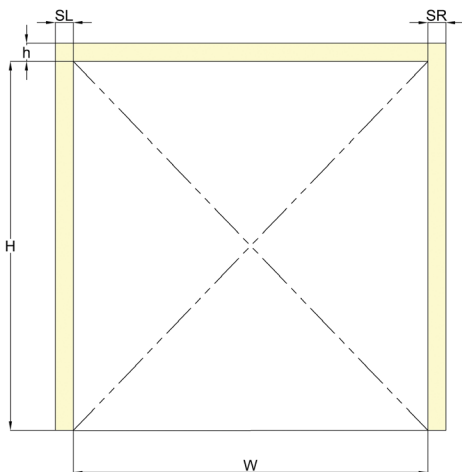
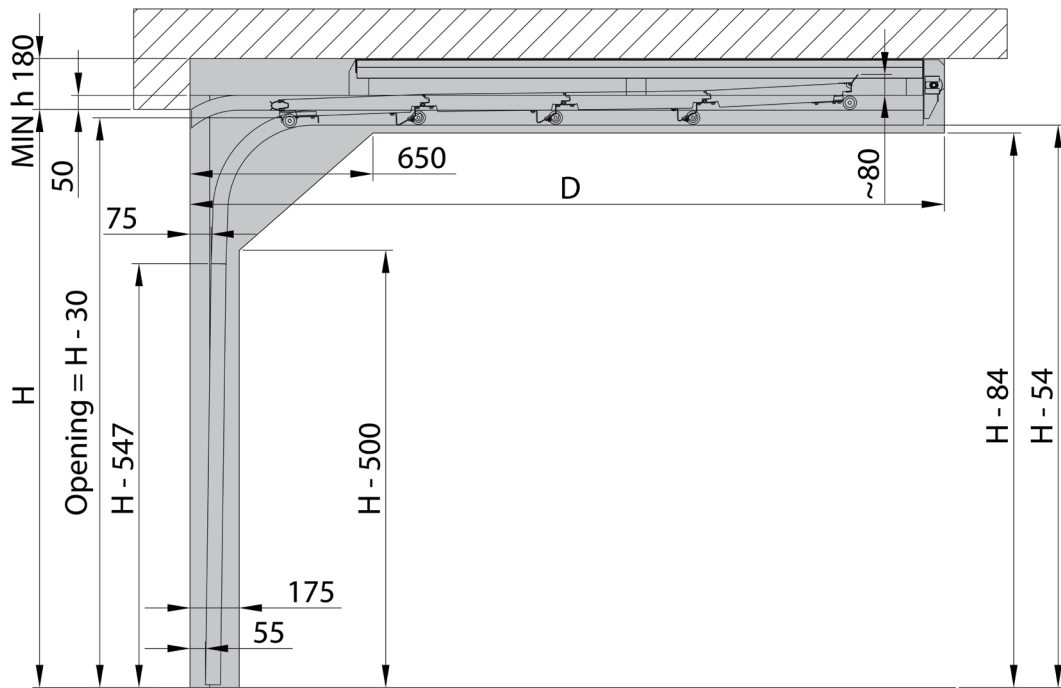

STANDARD

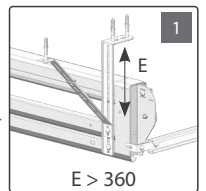

OPTIONAL

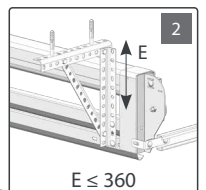

h (headroom)	180 (with el. operator and manual)
SL / SR (sideroom)	100
Daylight opening	H - 130 (manual) H - 10 (with el. operator) H - 60, W ≥ 4500 (with el. operator)
D (fitting depth)	H + 550

Number of required suspensions	
W ≤ 3000	1 suspension per side
W > 3000	2 suspensions per side

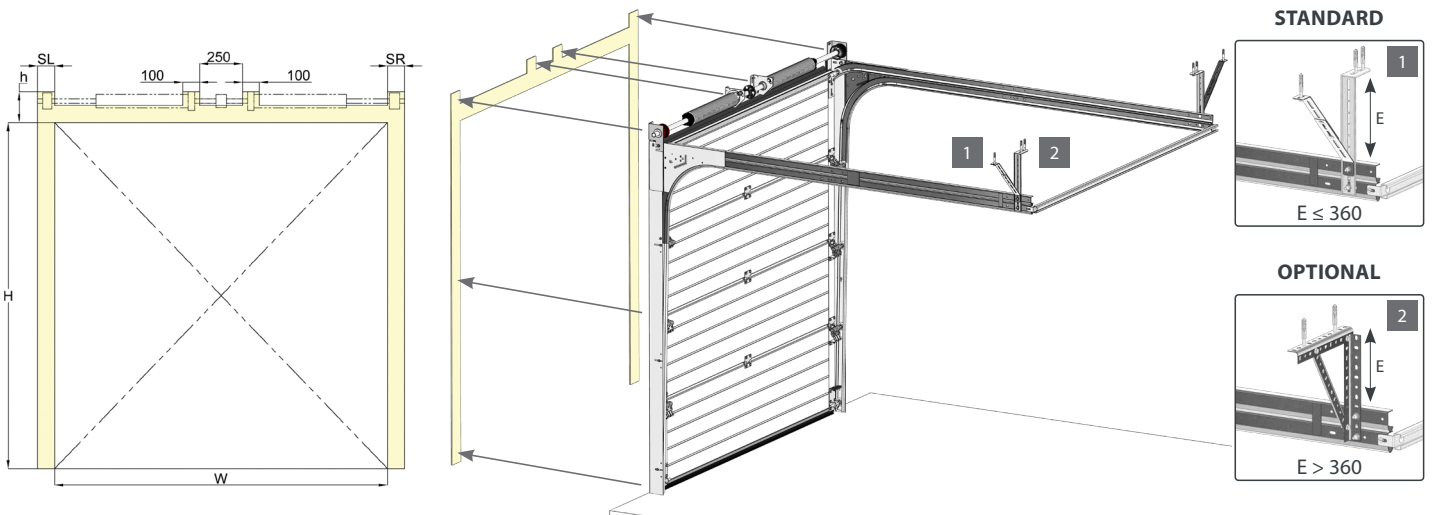
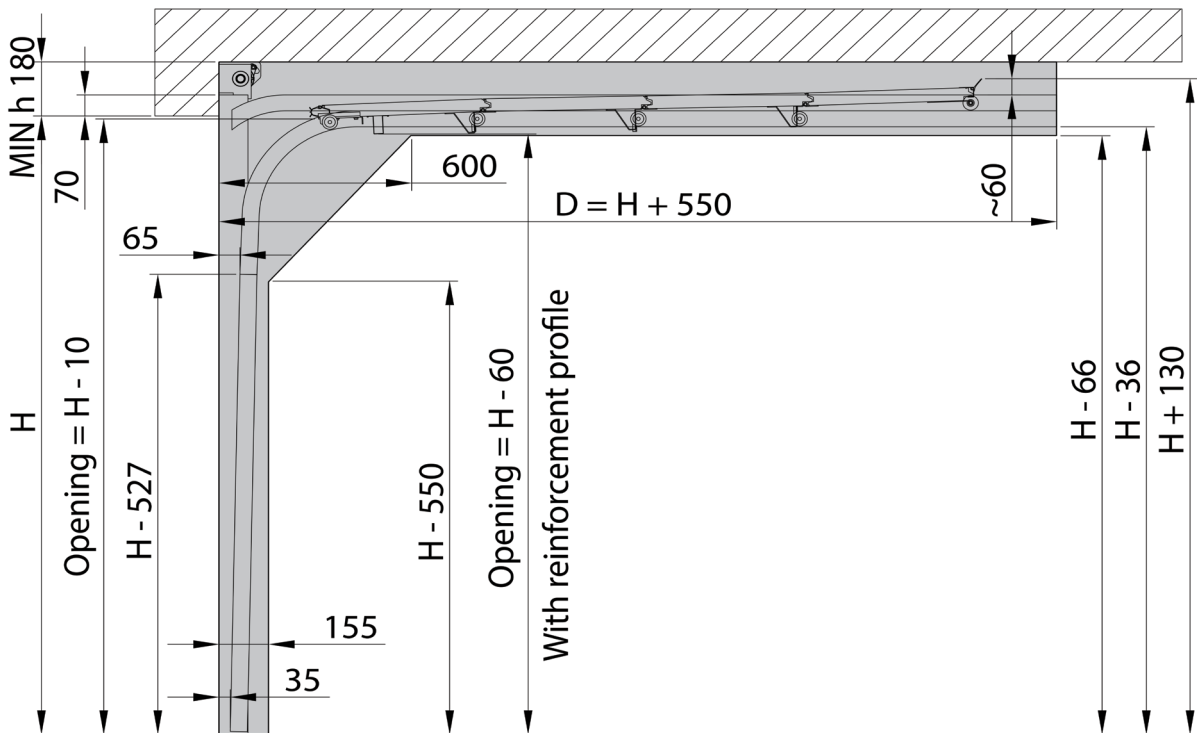
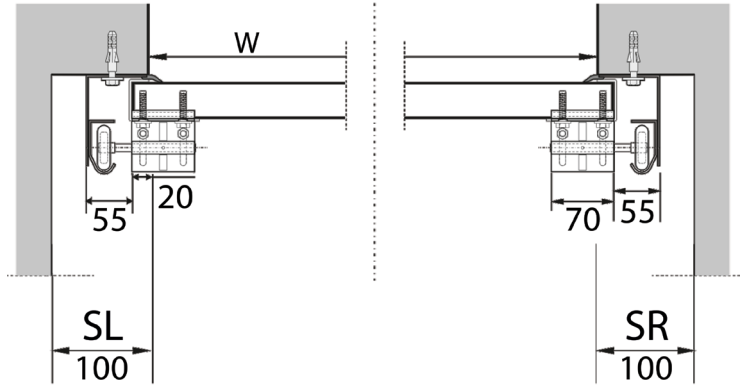

TL40 LHR - RM



h (headroom)	120 (manual) 160 (with el. operator)
SL / SR (sideroom)	100
Daylight opening	H - 160 (manual) H - 20 (with el. operator) H - 70, W ≥ 4500 (with el. operator)
D (fitting depth)	H + 700 H + 1100 with Sommer operator

Number of required suspensions	
W ≤ 3000	1 suspension per side
W > 3000	2 suspensions per side

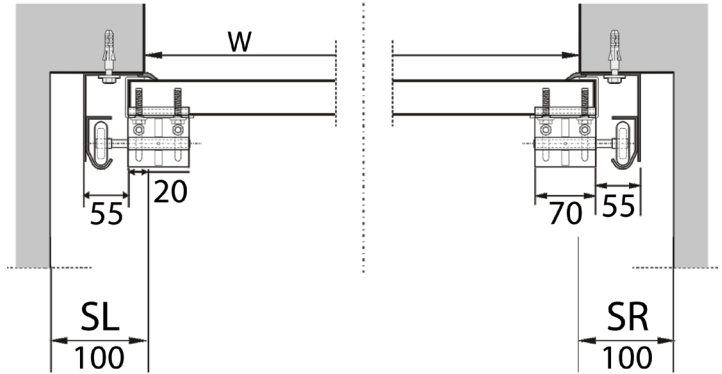

See page 18 for options to reduce required headroom and increase daylight opening.

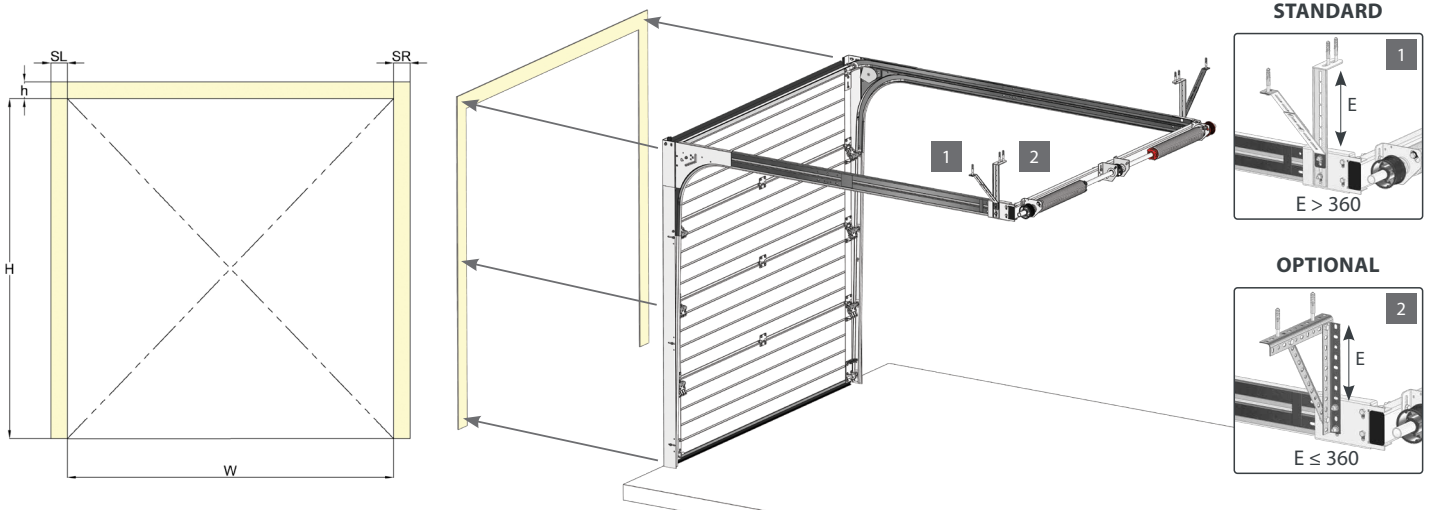
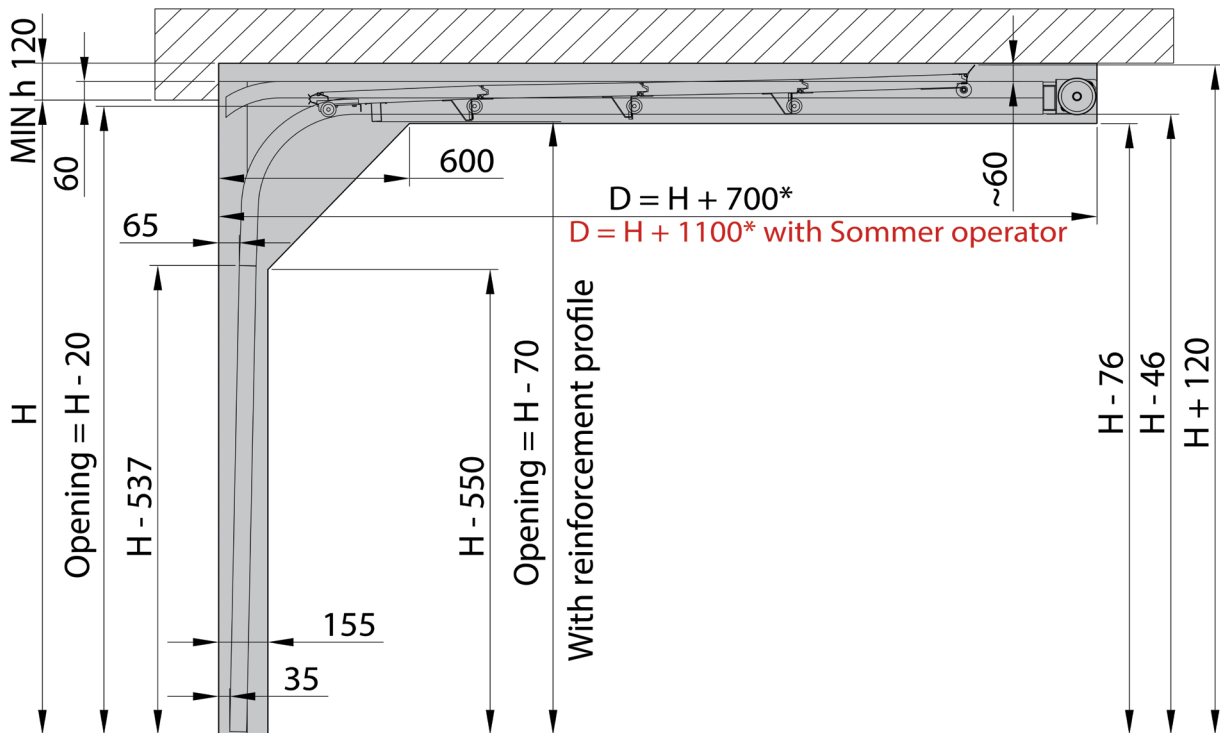

h (headroom)	340 (manual) 370 (with el. operator)
SL / SR (sideroom)	100
Daylight opening	H
D (fitting depth)	H + 510

Number of required suspensions	
W ≤ 3000	1 suspension per side
W > 3000	2 suspensions per side

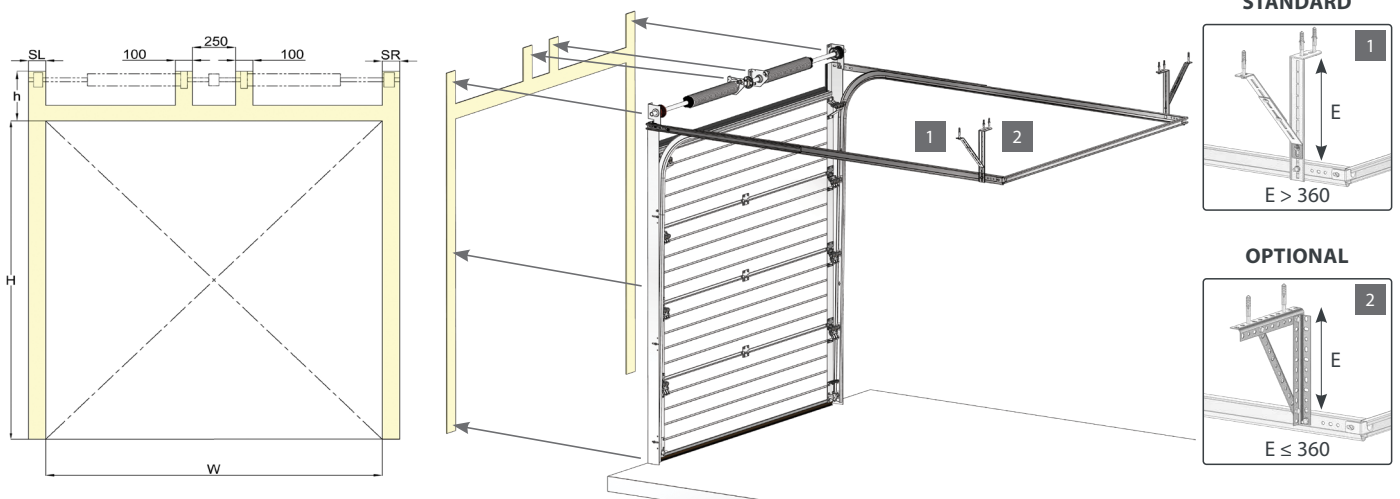
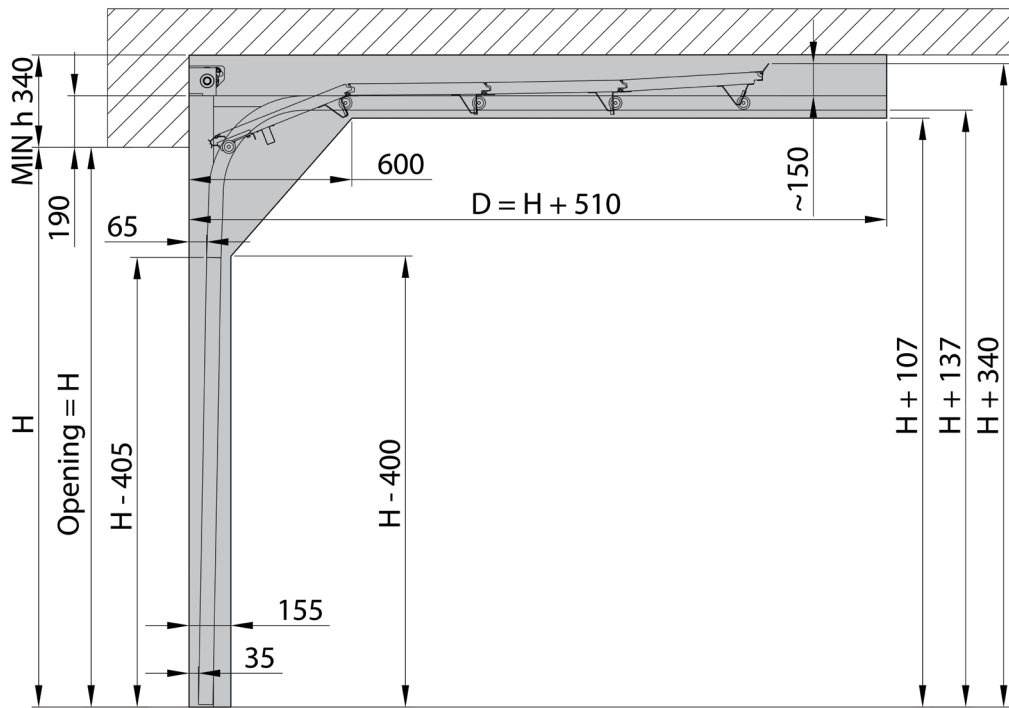
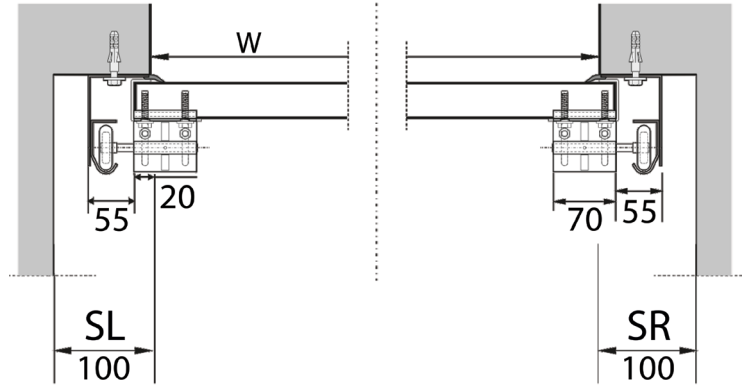

h (headroom)	180 (with el. operator and manual)
SL / SR (sideroom)	100
Daylight opening	H - 130 (manual) H - 10 (with el. operator) H - 50, W ≥ 4500 (with el. operator)
D (fitting depth)	H + 550

Number of required suspensions	
W ≤ 3000	1 suspension per side
W > 3000	2 suspensions per side

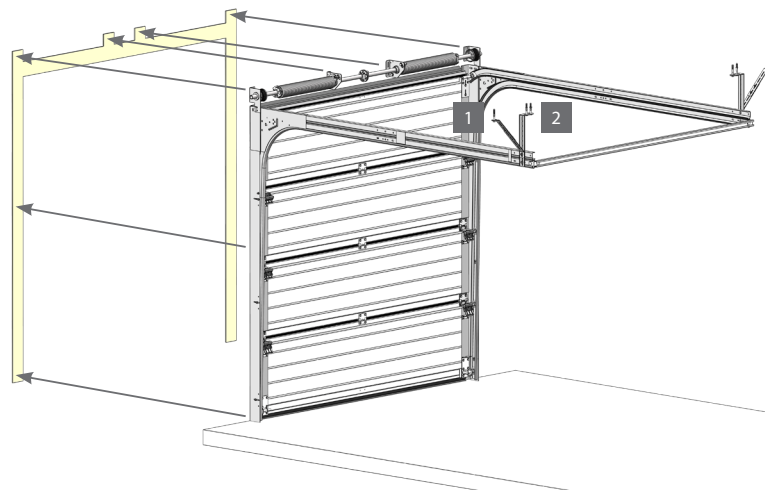
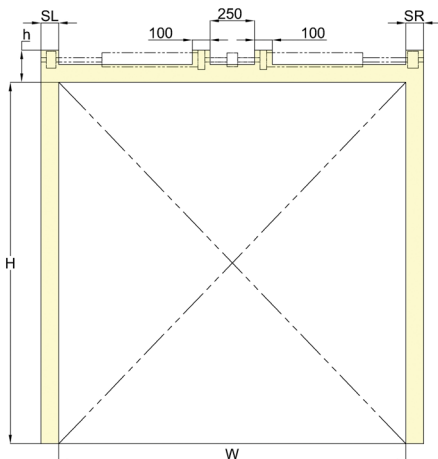
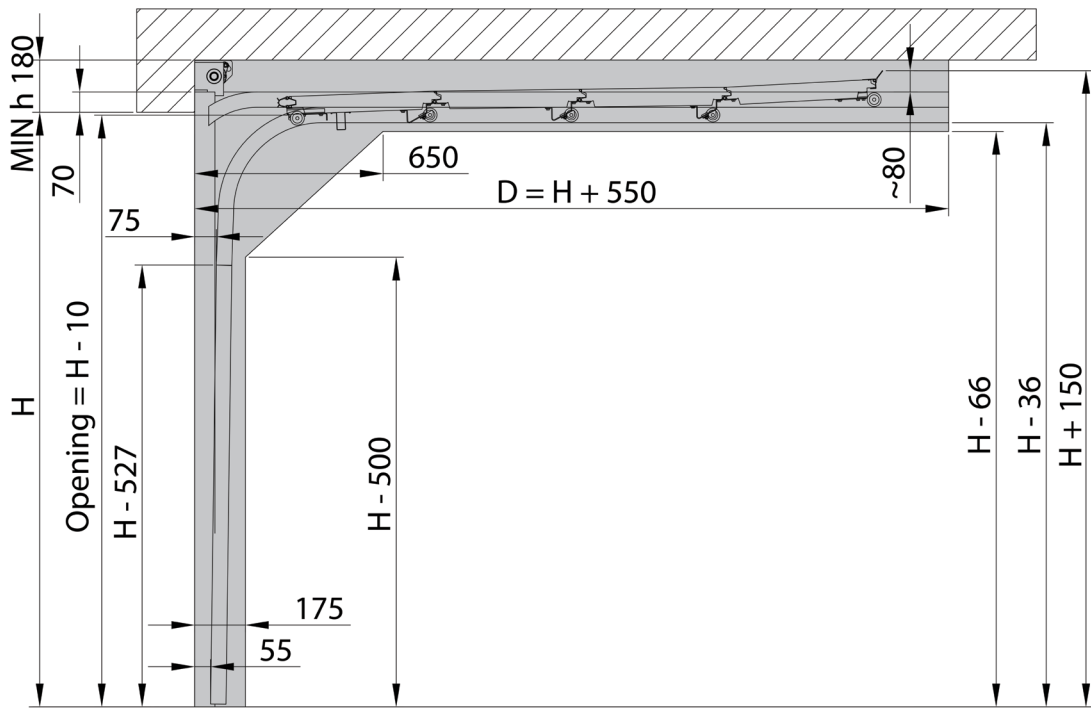
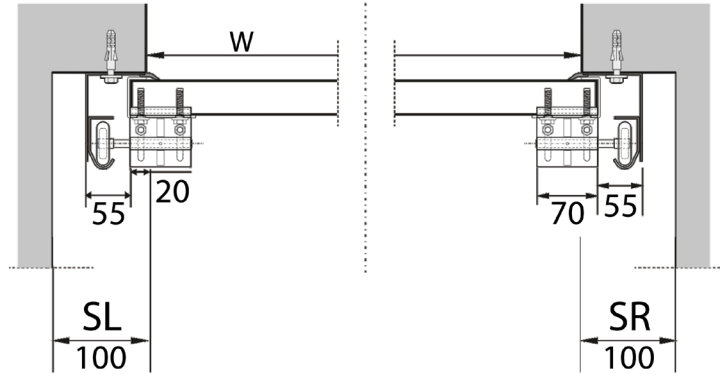

STANDARD

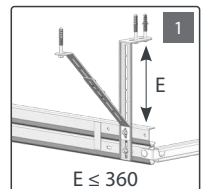

OPTIONAL

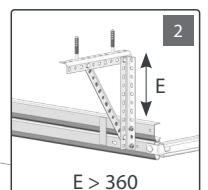

For W > 5000, consult the manufacturer regarding the quantity of springs.

h (headroom)	140 (manual) 180 (with el. operator)
SL / SR (sideroom)	100
Daylight opening	H - 160 (manual) H - 20 (with el. operator) H - 60, W ≥ 4500 (with el. operator)
D (fitting depth)	H + 700 H + 1100 with Sommer operator

Number of required suspensions	
W ≤ 3000	1 suspension per side
W > 3000	2 suspensions per side

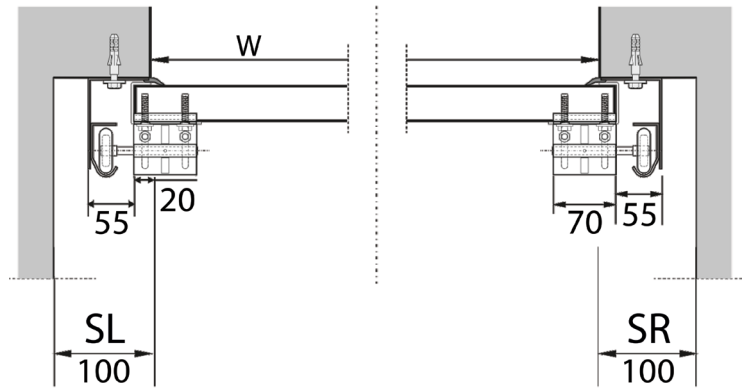

See page 18 for options to reduce required headroom and increase daylight opening.

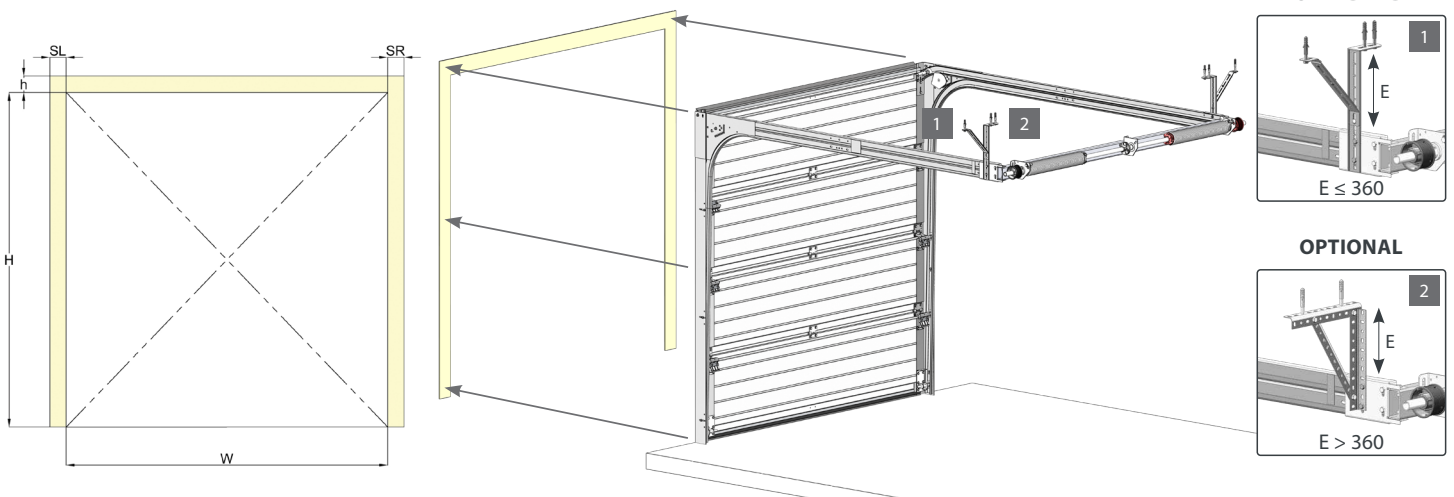
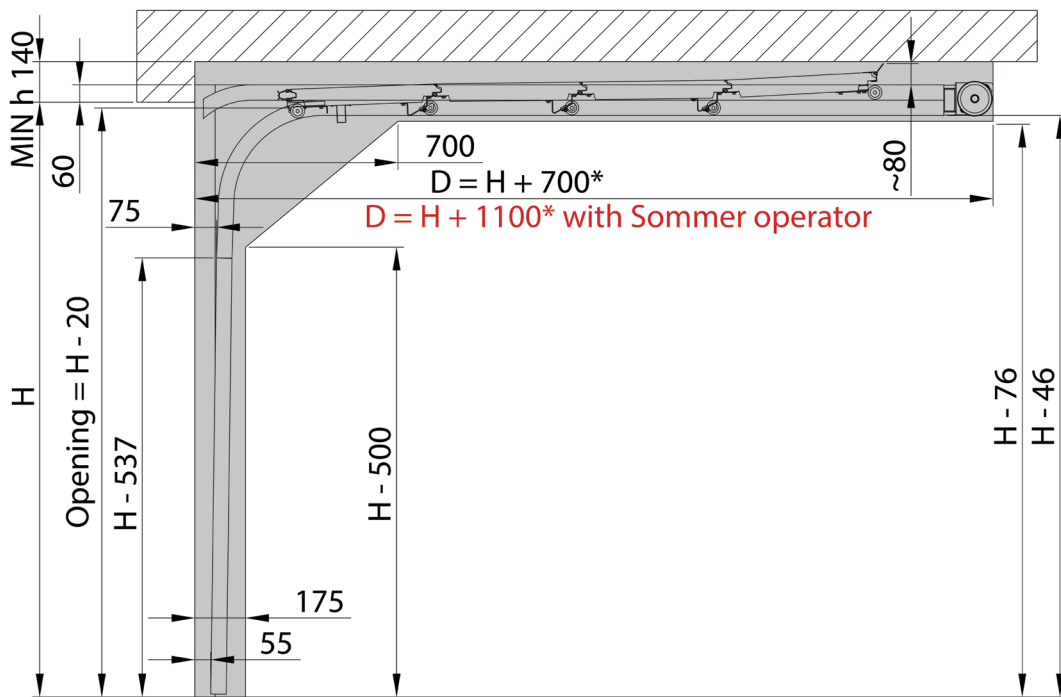

h (headroom)	360 (manual) 390 (with el. operator)
SL / SR (sideroom)	100
Daylight opening	H
D (fitting depth)	H + 510

Number of required suspensions	
W ≤ 3000	1 suspension per side
W > 3000	2 suspensions per side

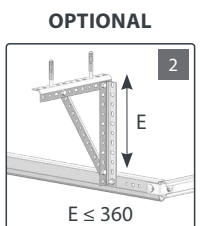
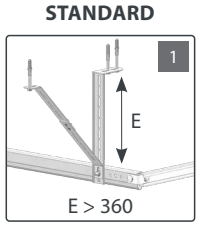
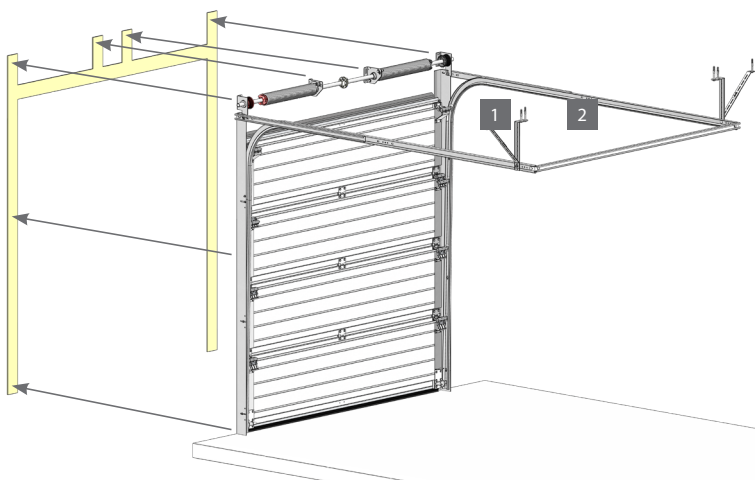
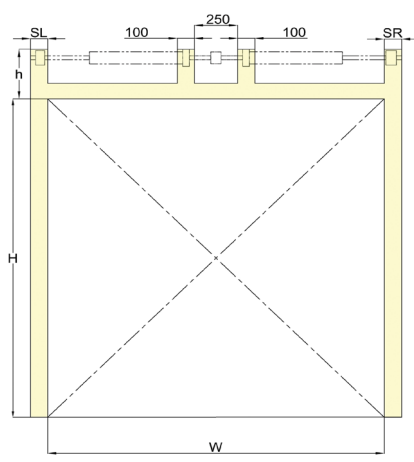
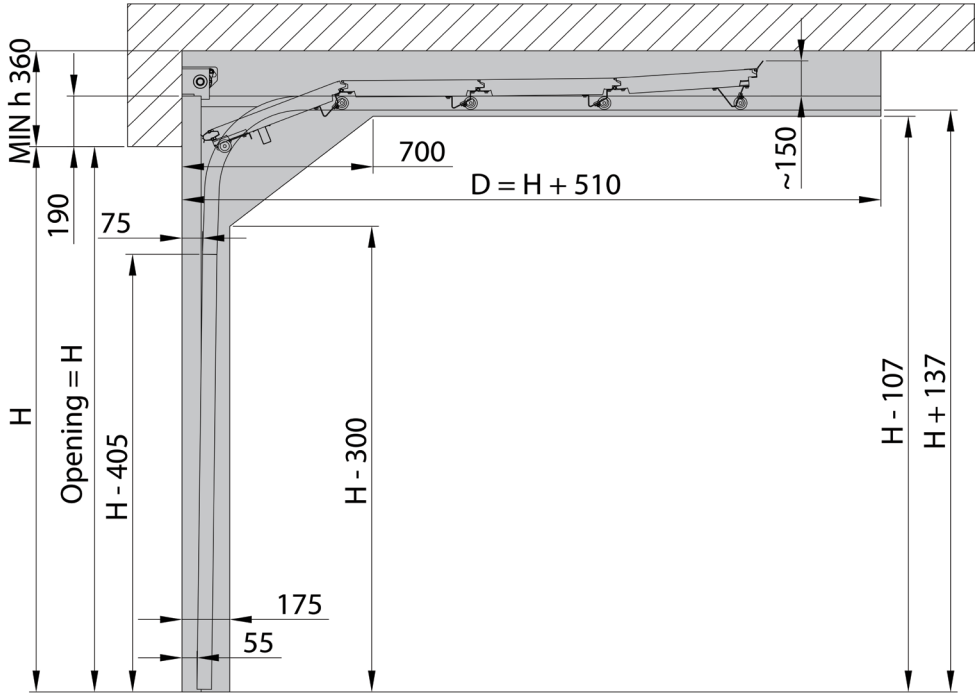
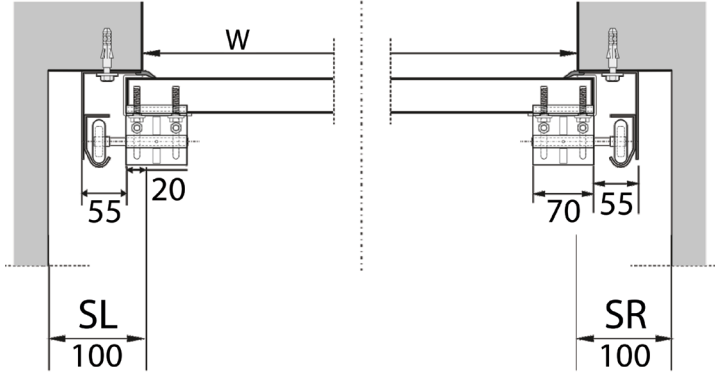

Additional options to reduce required headroom and increase daylight opening

Min headroom (mm)								
Equipment	Model							
	R40 SM		R40 UM		R40 TM		TL40 LHR-RM	
	Manual	Operator	Manual	Operator	Manual	Operator	Manual	Operator
Standard top brackets and top weather seal on panel	110	150	110	150	180	180	120	160
Standard top brackets and top weather seal on lintel	90	130	90	130	180	180	90	130
Top weather seal on lintel + LHR top brackets (18023)	70	110	-	-	180	180	80	120
Compact tracks* *Option available for doors up to (R40 3500, TL 4500) (opening width)	-	110 (70+40)	-	110 (70+40)	-	-	-	110 (70+40)*
Universal lock (22008)	95	-	95	-	180	-	105	-
Knob lock (22009)	100	-	100	-	180	-	110	-
With wicket door	-	-	-	-	-	-	105	-

Min headroom (mm)								
Equipment	Model							
	R60 SM		R60 UM		R60 TM		TL60 LHR-RM	
	Manual	Operator	Manual	Operator	Manual	Operator	Manual	Operator
Standard top brackets and top weather seal on panel	130	170	130	170	180	180	140	180
Standard top brackets and top weather seal on lintel	110	150	110	150	180	180	110	150
Top weather seal on lintel + LHR top brackets (18023)	90	130	-	-	180	180	100	140
Compact tracks	-	-	-	-	-	-	-	-
Universal lock (22008)	105	-	105	-	180	-	125	-
Knob lock (22009)	-	-	-	-	-	-	-	-
With wicket door	-	-	-	-	-	-	-	-

Max daylight opening (mm)							
Model							
R40 / R60 SM		R40 / R60 UM		R40 / R60 TM		TL40 / TL60 LHR-RM	
Manual	Operator	Manual	Operator	Manual	Operator	Manual	Operator
H-120	H-30	H-120	H-30	H-120	H-30	H-160	H-20 (W ≤ 4500) H-60 (W > 4500)

For full daylight opening use extended vertical tracks +30 (R40/R60 UM/SM/TM), +20 LHR-RM (W ≤ 4500).

You need more headroom (+30 or +20) then required min headroom.

Fitting depth (mm)								
Opening H, mm	Model							
	R40 / R60 SM		R40 / R60 UM		R40 / R60 TM		TL40 / TL60 LHR-RM	
	Manual	Operator	Manual	Operator	Manual	Operator	Manual	Operator
≤ 2070	2720		2680		2680		H+700	
2071-2270	2920		2880		2880		H+700	
2271-2400	3047		3007		3007		H+700	
2401-2500	3300		3260		3260		H+700	

Min sideroom (mm)			
Model			
R40 / R60 SM	R40 / R60 UM	R40 / R60 TM	TL40 / TL60 LHR-RM
150	80	80	100

h (headroom)	Refer to page 22
SL / SR (sideroom)	100
Daylight opening	H - 130 (manual) H - 10 (with el. operator) H - 50, W ≥ 4500 (with el. operator)
D (fitting depth)	H + 550

Number of required suspensions	
W ≤ 3000	1 suspension per side
W > 3000	2 suspensions per side

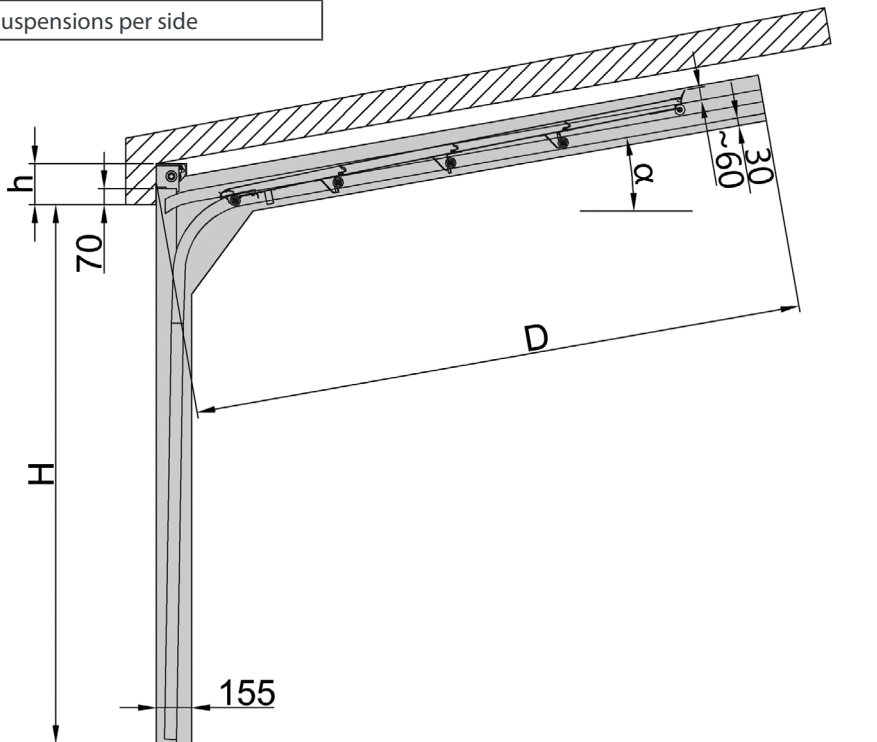
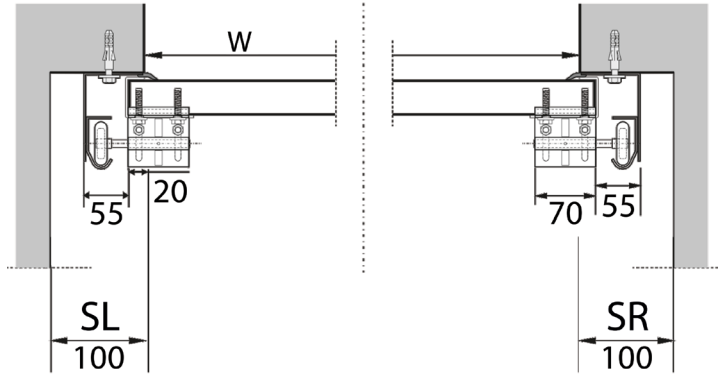

Regarding quantity of springs consult manufacturer.

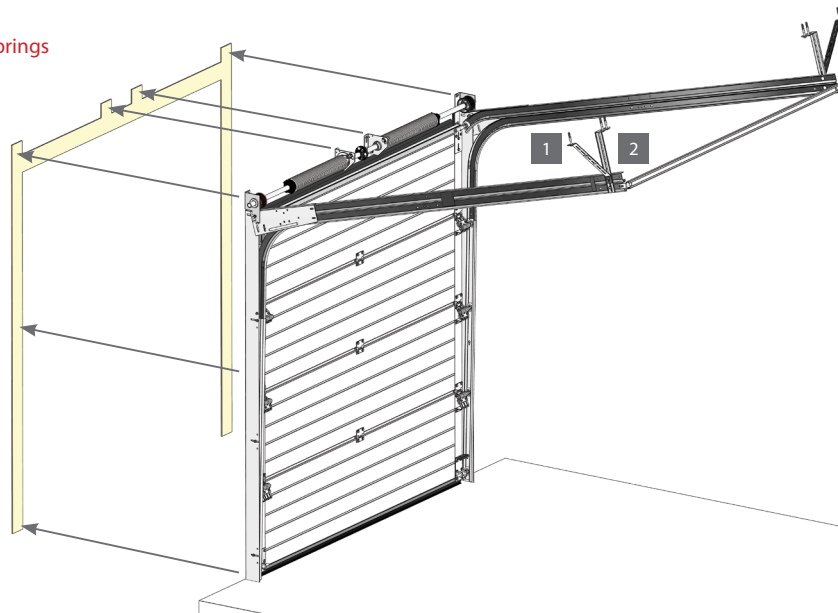

STANDARD

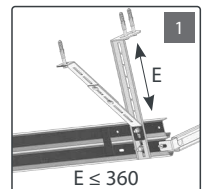

OPTIONAL

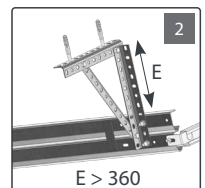

h (headroom)	120 (manual) $\alpha \leq 15^\circ$ 160 (with el. operator) $\alpha \leq 15^\circ$ *for bigger angle consult manufacturer
SL / SR (sideroom)	100
Daylight opening	H - 160 (manual) H - 20 (with el. operator) H - 60, W \geq 4500 (with el. operator)
D (fitting depth)	H + 700 H + 1100 (with Sommer operator)

Number of required suspensions	
W \leq 3000	1 suspension per side
W $>$ 3000	2 suspensions per side

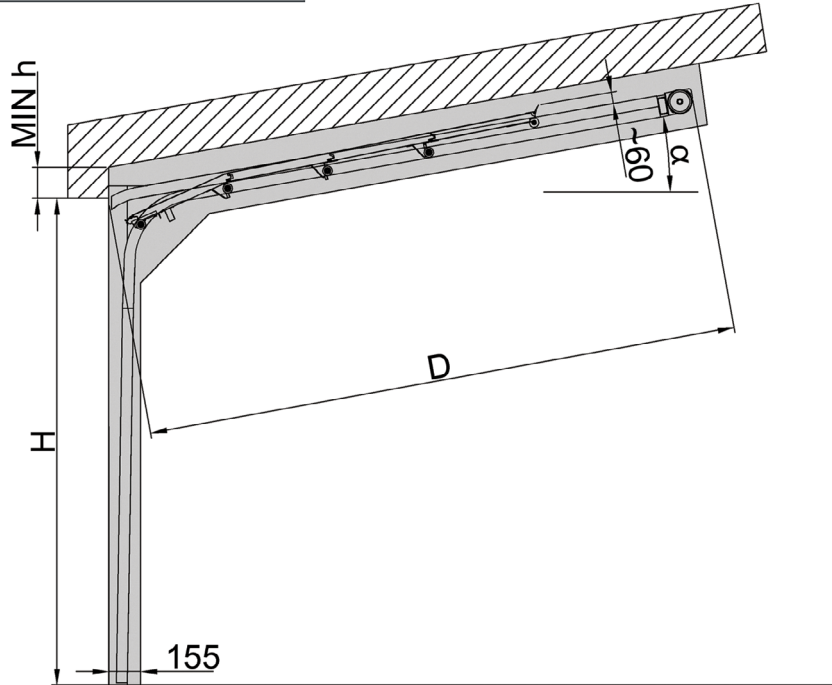
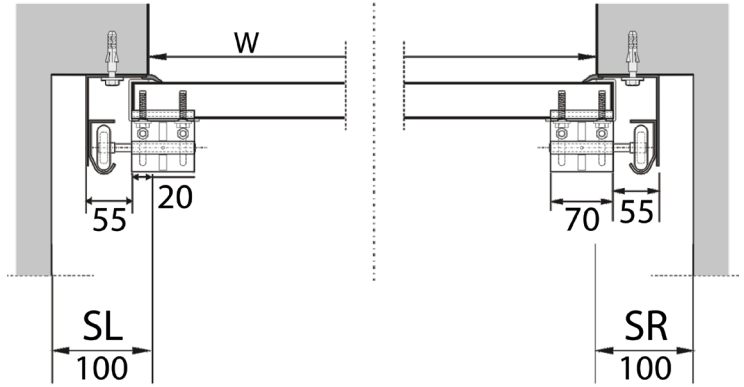

Regarding quantity of springs consult manufacturer.

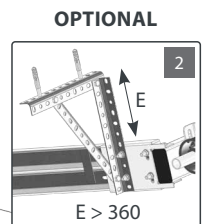
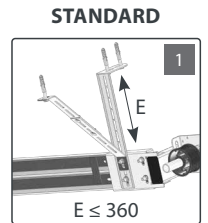
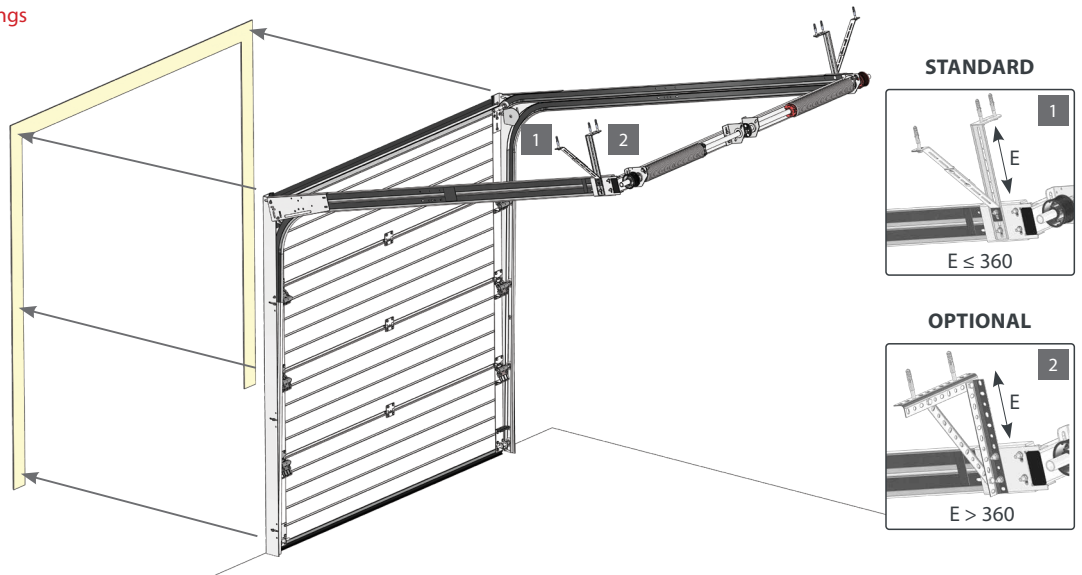

h (headroom)	Refer to page 22
SL / SR (sideroom)	100
Daylight opening	H
D (fitting depth)	H + 510

Number of required suspensions	
W ≤ 3000	1 suspension per side
W > 3000	2 suspensions per side

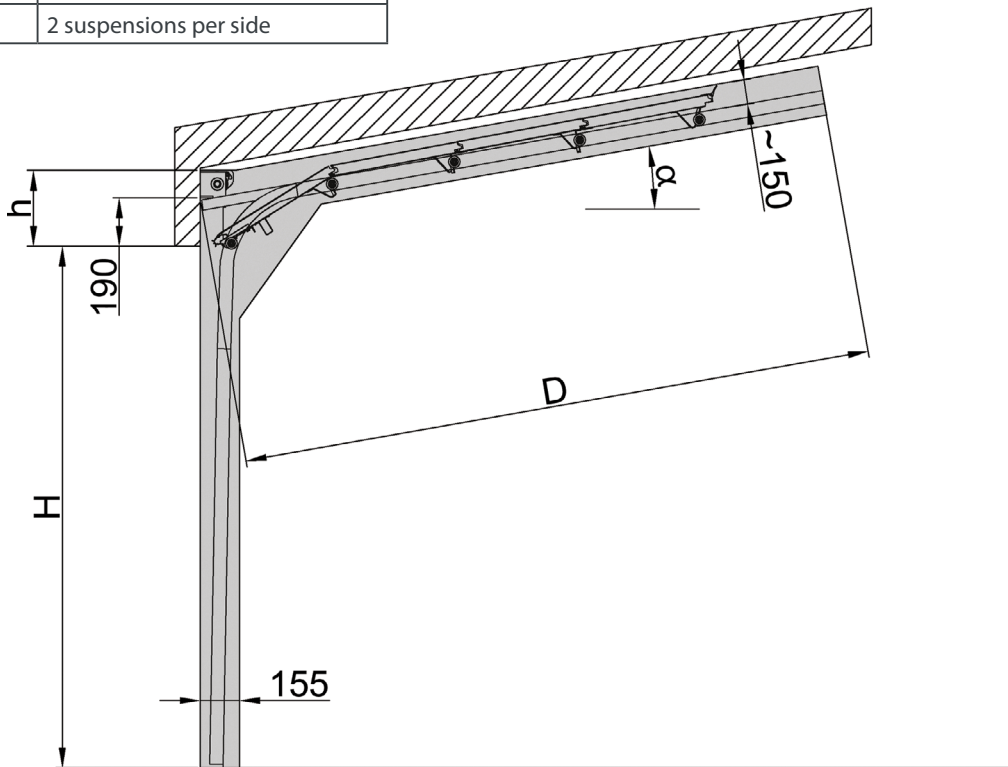
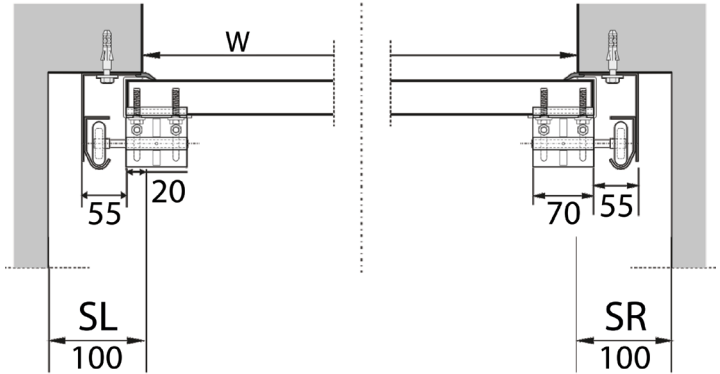

Regarding quantity of springs consult manufacturer.

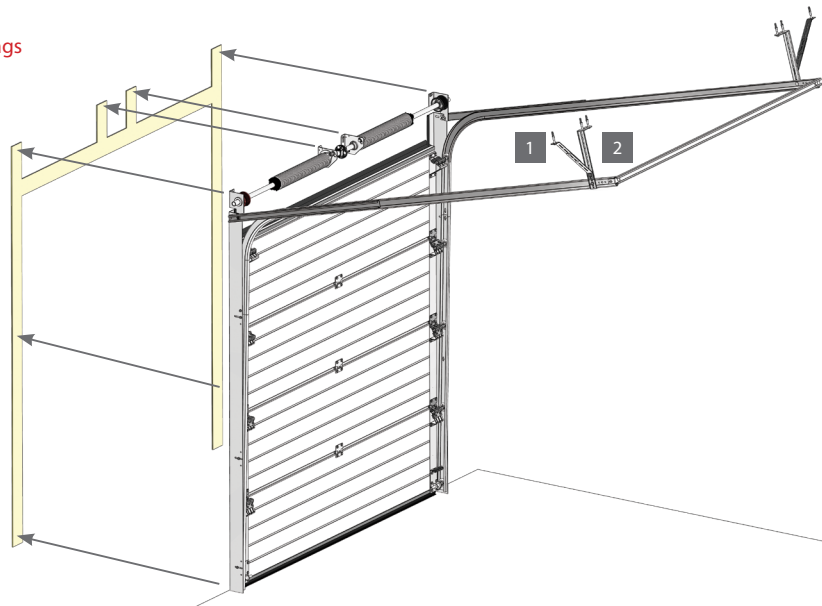

STANDARD

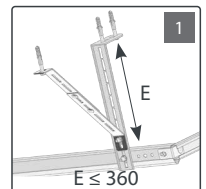

OPTIONAL

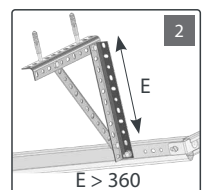

Door size, pitch angle and required headroom correlation



All sizes are for doors without operator.

TL40 Required headroom for doors with Woodgrain / Stucco panels										
	$\alpha \leq 10^\circ$		$10^\circ < \alpha \leq 15^\circ$		$15^\circ < \alpha \leq 20^\circ$		$20^\circ < \alpha \leq 25^\circ$		$25^\circ < \alpha \leq 30^\circ$	
	STD	LHR-FM	STD	LHR-FM	STD	LHR-FM	STD	LHR-FM	STD	LHR-FM
H ≤ 2000	340	180	340	180	340	180	340	180	370	270
H ≤ 2250	340	180	340	180	340	180	340	180	370	270
H ≤ 2500	340	180	340	180	340	180	340	180	370	270
H ≤ 2750	340	180	340	180	370	270	370	270	370	270
H ≤ 3000	340	180	340	180	370	270	370	270	370	270

TL40 Required headroom for doors with Woodgrain / Stucco panels and wicket door										
	$\alpha \leq 10^\circ$		$10^\circ < \alpha \leq 15^\circ$		$15^\circ < \alpha \leq 20^\circ$		$20^\circ < \alpha \leq 25^\circ$		$25^\circ < \alpha \leq 30^\circ$	
	STD	LHR-FM	STD	LHR-FM	STD	LHR-FM	STD	LHR-FM	STD	LHR-FM
H ≤ 2000	340	180	340	180	340	180	340	180	370	270
H ≤ 2250	340	180	340	180	340	180	370	270	370	270
H ≤ 2500	340	180	340	180	340	180	370	270	370	270
H ≤ 2750	340	180	340	180	340	180	370	270	370	270
H ≤ 3000	340	180	340	180	340	180	370	270	370	270

TL40 Required headroom for doors with smooth (SLICK type) panels										
	$\alpha \leq 10^\circ$		$10^\circ < \alpha \leq 15^\circ$		$15^\circ < \alpha \leq 20^\circ$		$20^\circ < \alpha \leq 25^\circ$		$25^\circ < \alpha \leq 30^\circ$	
	STD	LHR-FM	STD	LHR-FM	STD	LHR-FM	STD	LHR-FM	STD	LHR-FM
H ≤ 2000	340	180	340	180	340	180	340	180	340	180
H ≤ 2250	340	180	340	180	340	180	340	180	370	270
H ≤ 2500	340	180	340	180	340	180	370	270	370	270
H ≤ 2750	340	180	340	180	340	180	370	270	370	270
H ≤ 3000	340	180	340	180	340	180	370	270	370	270

TL40 Required headroom for doors with smooth (SLICK type) panels and wicket door										
	$\alpha \leq 10^\circ$		$10^\circ < \alpha \leq 15^\circ$		$15^\circ < \alpha \leq 20^\circ$		$20^\circ < \alpha \leq 25^\circ$		$25^\circ < \alpha \leq 30^\circ$	
	STD	LHR-FM	STD	LHR-FM	STD	LHR-FM	STD	LHR-FM	STD	LHR-FM
H ≤ 2000	340	180	340	180	340	180	340	180	340	180
H ≤ 2250	340	180	340	180	340	180	340	180	370	270
H ≤ 2500	340	180	340	180	340	180	370	270	370	270
H ≤ 2750	340	180	340	180	370	270	370	270	370	270
H ≤ 3000	340	180	340	180	370	270	370	270	370	270

TL60 Required headroom for doors with smooth (SLICK type) panels										
	$\alpha \leq 10^\circ$		$10^\circ < \alpha \leq 15^\circ$		$15^\circ < \alpha \leq 20^\circ$		$20^\circ < \alpha \leq 25^\circ$		$25^\circ < \alpha \leq 30^\circ$	
	STD	LHR-FM	STD	LHR-FM	STD	LHR-FM	STD	LHR-FM	STD	LHR-FM
H ≤ 2000	360	180	360	180	360	180	360	180	390	270
H ≤ 2250	360	180	360	180	360	180	360	180	390	270
H ≤ 2500	360	180	360	180	390	270	390	270	390	270
H ≤ 2750	360	180	360	180	390	270	390	270	390	270
H ≤ 3000	360	180	360	180	390	270	390	270	390	270

STANDARD SIDEROOM

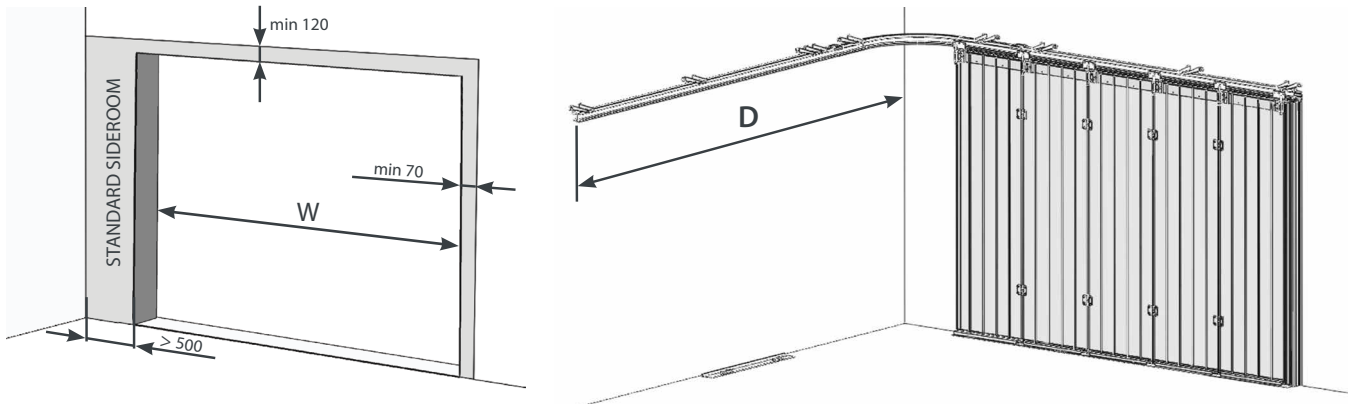

SMALL SIDEROOM

Sideroom*	Radius	Arm	D	Operator fitting place***
150 - 200	R520	R520 + ARM L = 1000	W + 1250	Side wall only
201 - 300	R520	R520 + ARM L = 600	W + 800	Side wall
301 - 500	R520	R520 + ARM L = 400	W + 600	Side wall
> 500	R420	-	W + 100	Lintel

*Min sideroom on opening side (for manual operator min 200 required).

**Max 500 sideroom with operator on the side wall.

***Operator movement range must be longer than W, if standard rail is too short use additional rail extensions.

****Sideroom for a different distance, consult the manufacturer regarding the specific operator.

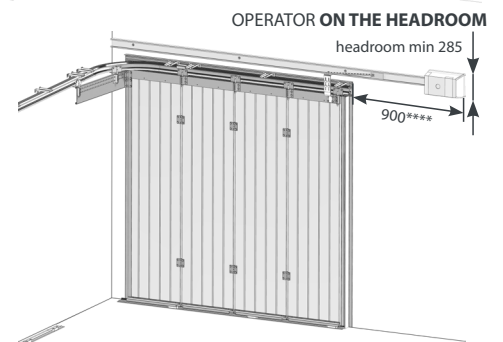
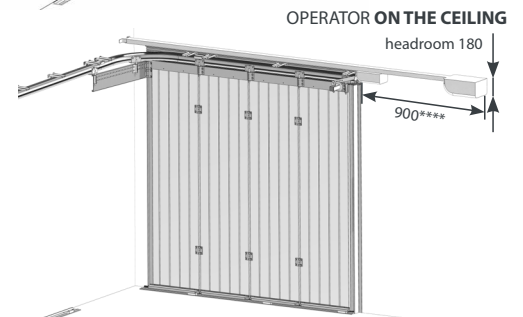
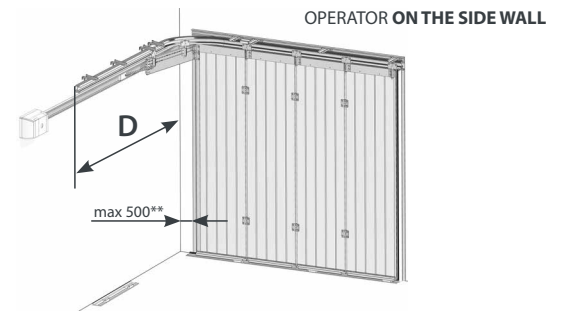
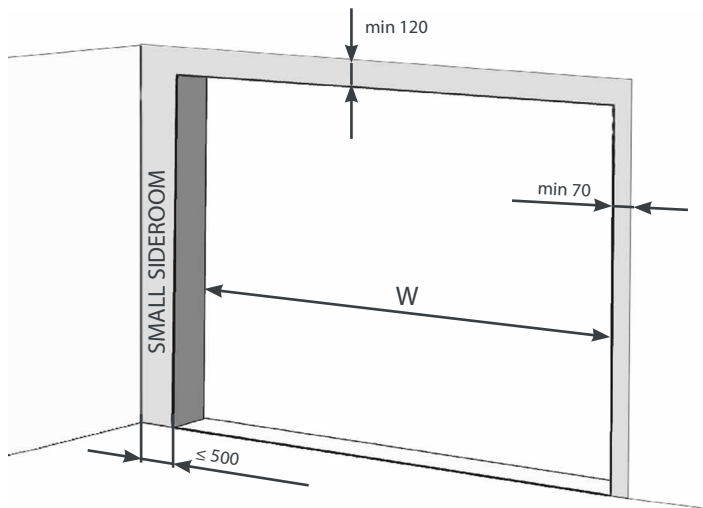

Single door
H = max 3000, W = max 6000

Angle ranges
 $\alpha = \text{min } 85^\circ, \text{ max } 180^\circ$

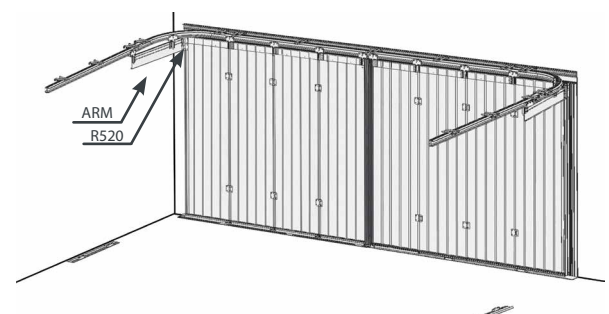
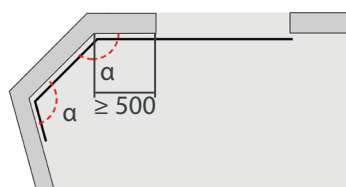
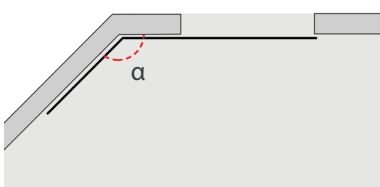

PANELS

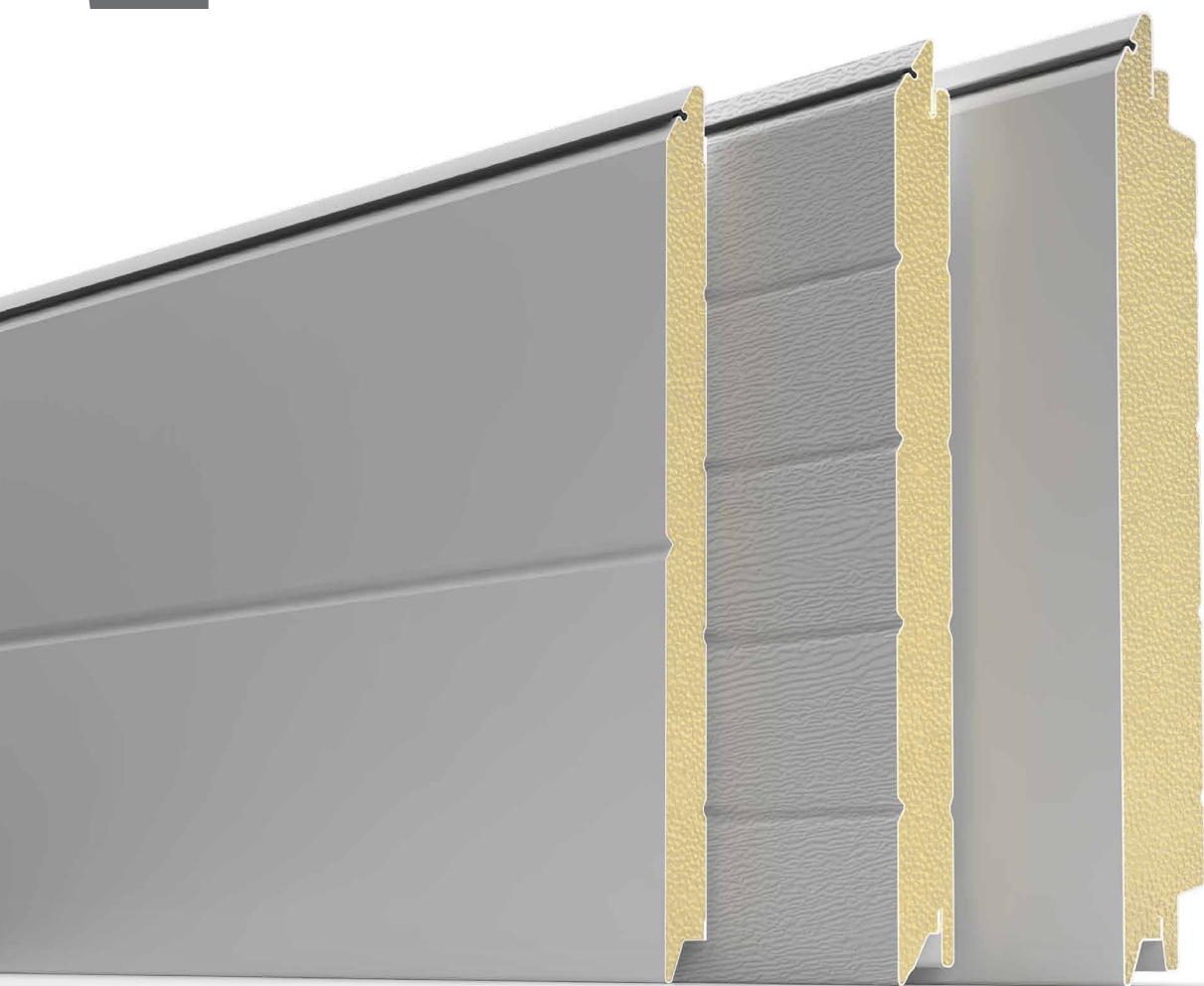

Panel type	S (mm)	Panel weight		Tolerances			U value			
		Kg/m	Kg/m ²	Thickness	Width	Length	W/m ² K			
R - 500	40	4,74	9,5	+/- 2	+/- 1	+/- 5	0,53			
R - 610		5,65	9,3							
R - 500	60	6,49	12,9							0,36
R - 610		7,85								

Section type*	U value (W/m ² K)	Wind load resistance class	Water penetration class	Air permeability class
Sandwich	0,93 - 1,5	5	3	2

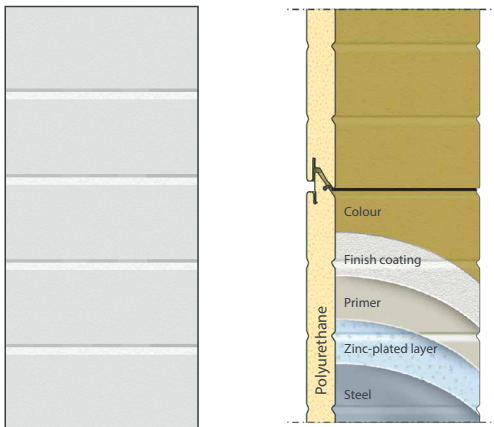

All panels internal side - ribbed, Stucco embossed RAL 9002.

RIB

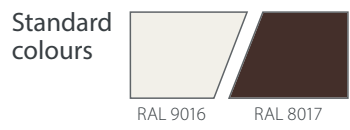
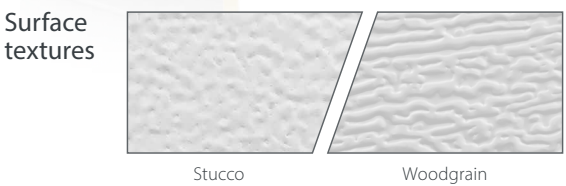
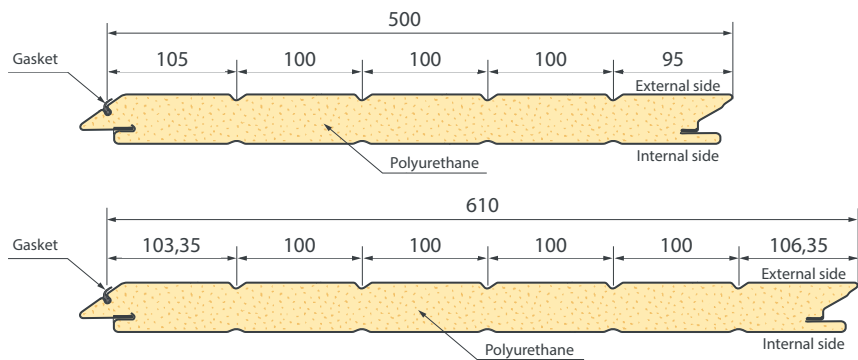
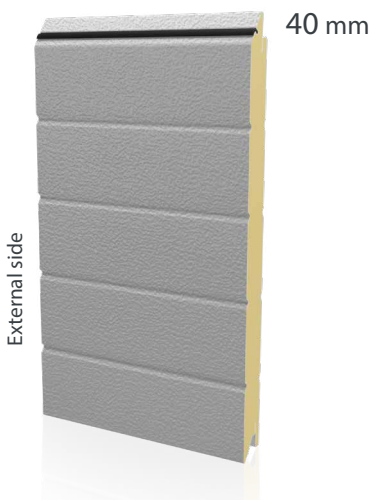

Other painted colours similar to RAL palette

Exact door classifications are calculated for each door individually and may differ from the numbers listed above. The precise values depend on the specific size and configuration of each door.
*Other specific colours and the NCS palette are available on request.

All dimensions are given in millimetres (mm).

FLUSH

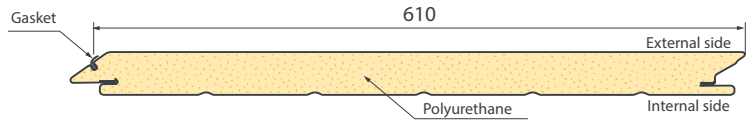
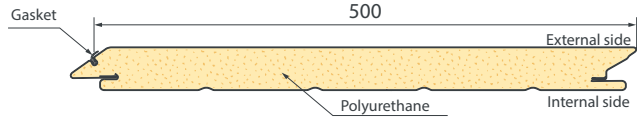
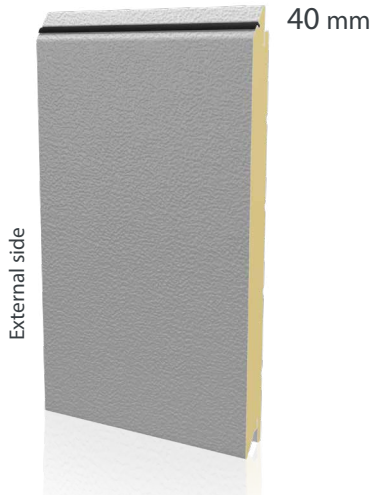

Surface textures

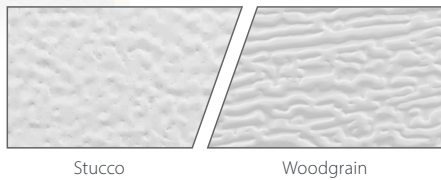

Standard colours

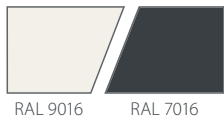

Other painted colours similar to RAL palette

*Other specific colours and the NCS palette are available on request.

SLICK

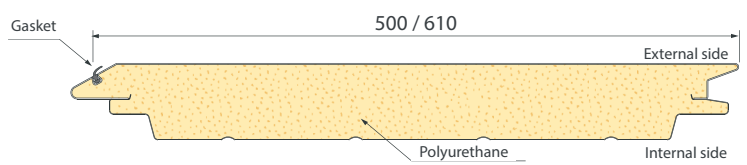
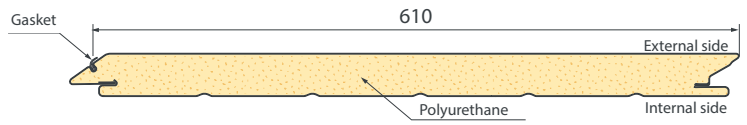
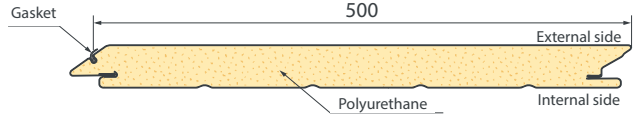
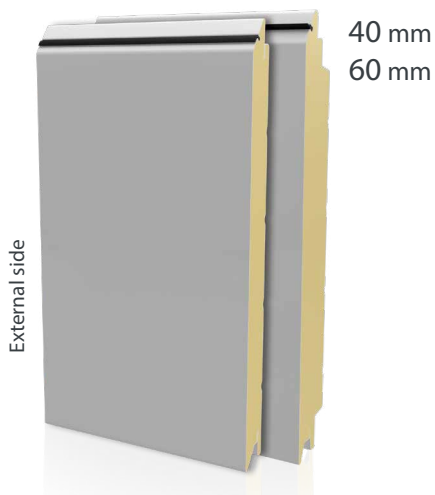

Surface texture



Standard colours 40 mm

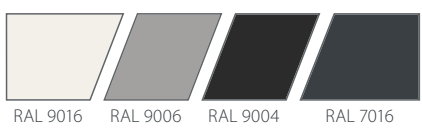

Standard colours 60 mm

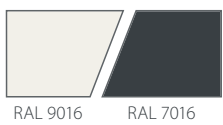

Other painted colours similar to RAL palette

RAL pearl colours

*Other specific colours and the NCS palette are available on request.
**Smooth surface only

SLICK PLUS

Surface textures

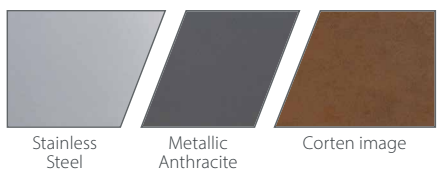

GEORGIAN (CASSETTE)

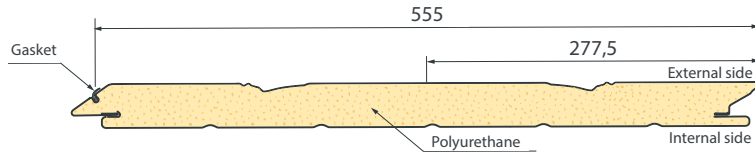
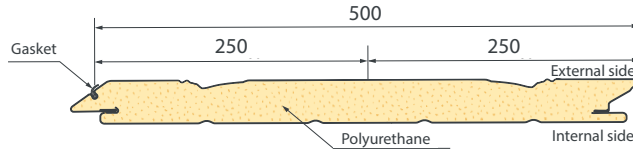
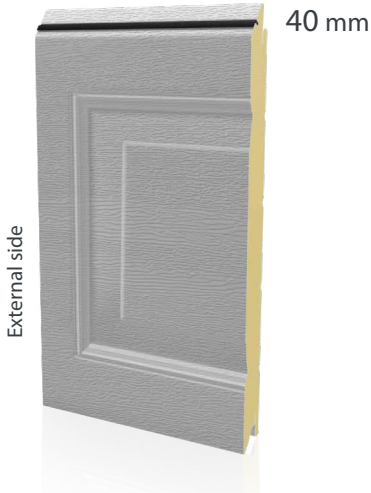

Surface texture

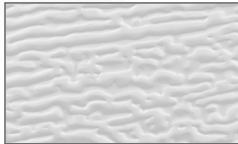

Standard colours



Other painted colours similar to RAL palette



*Other specific colours and the NCS palette are available on request.

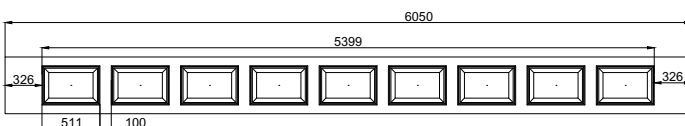
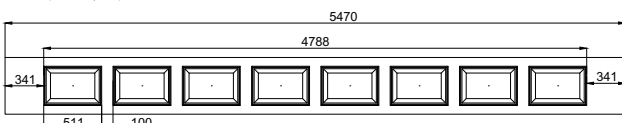
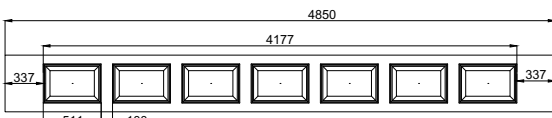
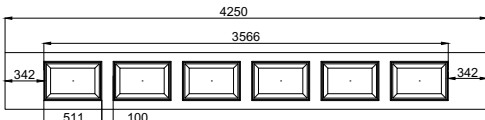
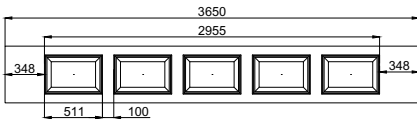
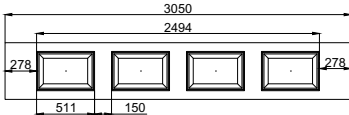
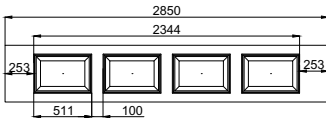
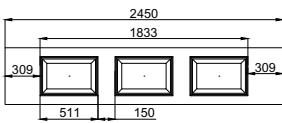

MIDRIB

External side

40 mm
30 mm

500/526
250 / 263
250 / 263
External side
Internal side
Polyurethane
30 mm
Woodgrain only

500
250
250
External side
Internal side
Polyurethane

610
360
250
External side
Internal side
Polyurethane
Top panel

610
250
360
External side
Internal side
Polyurethane
Bottom panel

Surface textures

Stucco Woodgrain Smooth

Standard colours 40 mm

RAL 9016 Woodgrain Stucco RAL 8017 Woodgrain RAL 7016 Woodgrain RAL 6009 Woodgrain

Wood images Smooth

Light Oak Golden Oak Old Oak Dark Oak Mahogany Winchester

Standard colours 30 mm

RAL 9016 Woodgrain RAL 7016 Woodgrain

Other painted colours similar to RAL palette *

RAL pearl colours **

*Other specific colours and the NCS palette are available on request.
**Smooth surface only.

TOPRIB

External side

40 mm

500
105
395
External side
Internal side
Polyurethane

610
103,65
506,35
External side
Internal side
Polyurethane

Surface texture

Smooth

Standard colours

RAL 9016 RAL 7016

Other painted colours similar to RAL palette *

RAL pearl colours **

*Other specific colours and the NCS palette are available on request.
**Smooth surface only.

MICRORIB

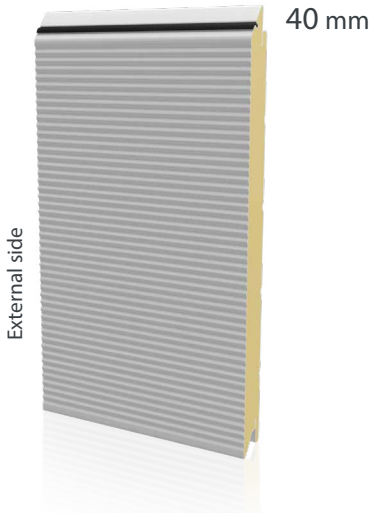

40 mm

External side

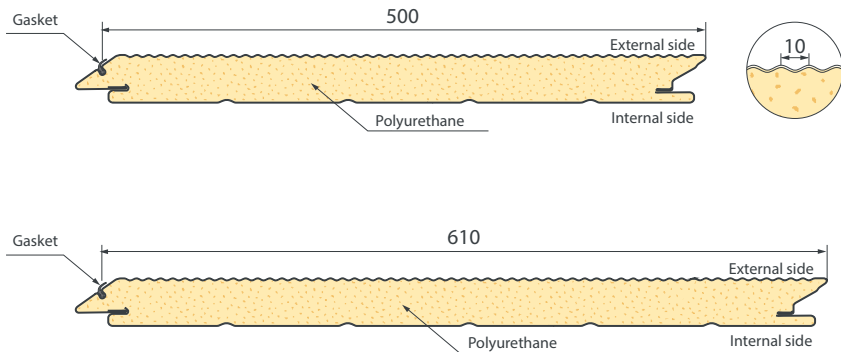

Surface texture



Smooth

Standard colours



RAL 9016

Other painted colours similar to RAL palette *

RAL pearl colours **

*Other specific colours and the NCS palette are available on request.
**Smooth surface only.

MACRORIB

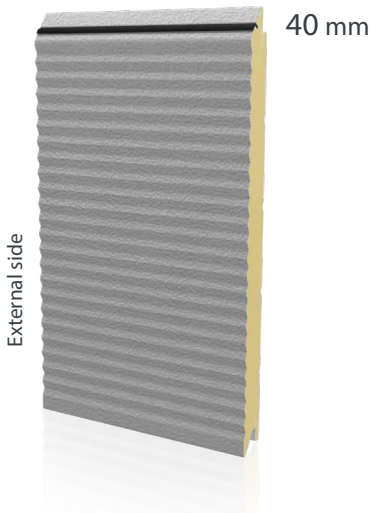

40 mm

External side

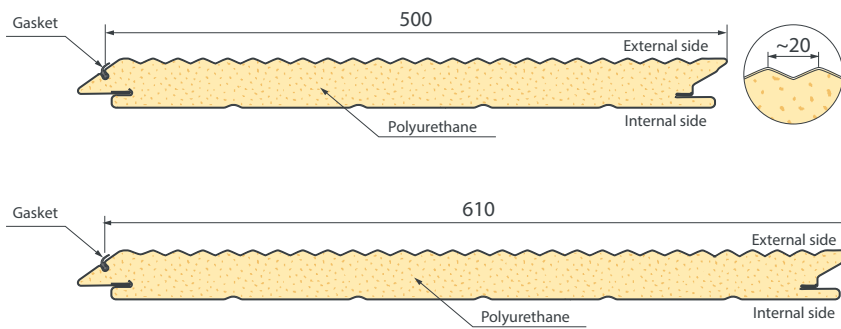

Surface texture



Stucco

Standard colours



RAL 9016

RAL 9007

RAL 7016

Other painted colours similar to RAL palette *

*Other specific colours and the NCS palette are available on request.

Reinforcement profiles on sandwich panels

Opening width, W	Profile type	Example No.	Main location on panel	Quantity of reinforcements
$W \leq 4500$	-	-	-	-
$4500 < W \leq 5000$	Bottom reinforced + omega	1-A	Top of panel (for omega)	$1 + 1 = 2$
	Omega	1-B		Top of panel
$5000 < W \leq 5500$	Omega	2	Top partition of panel	On every second door panel
$5500 < W \leq 6000$	Omega	3	Top of panel	On every second door panel + 1 on top

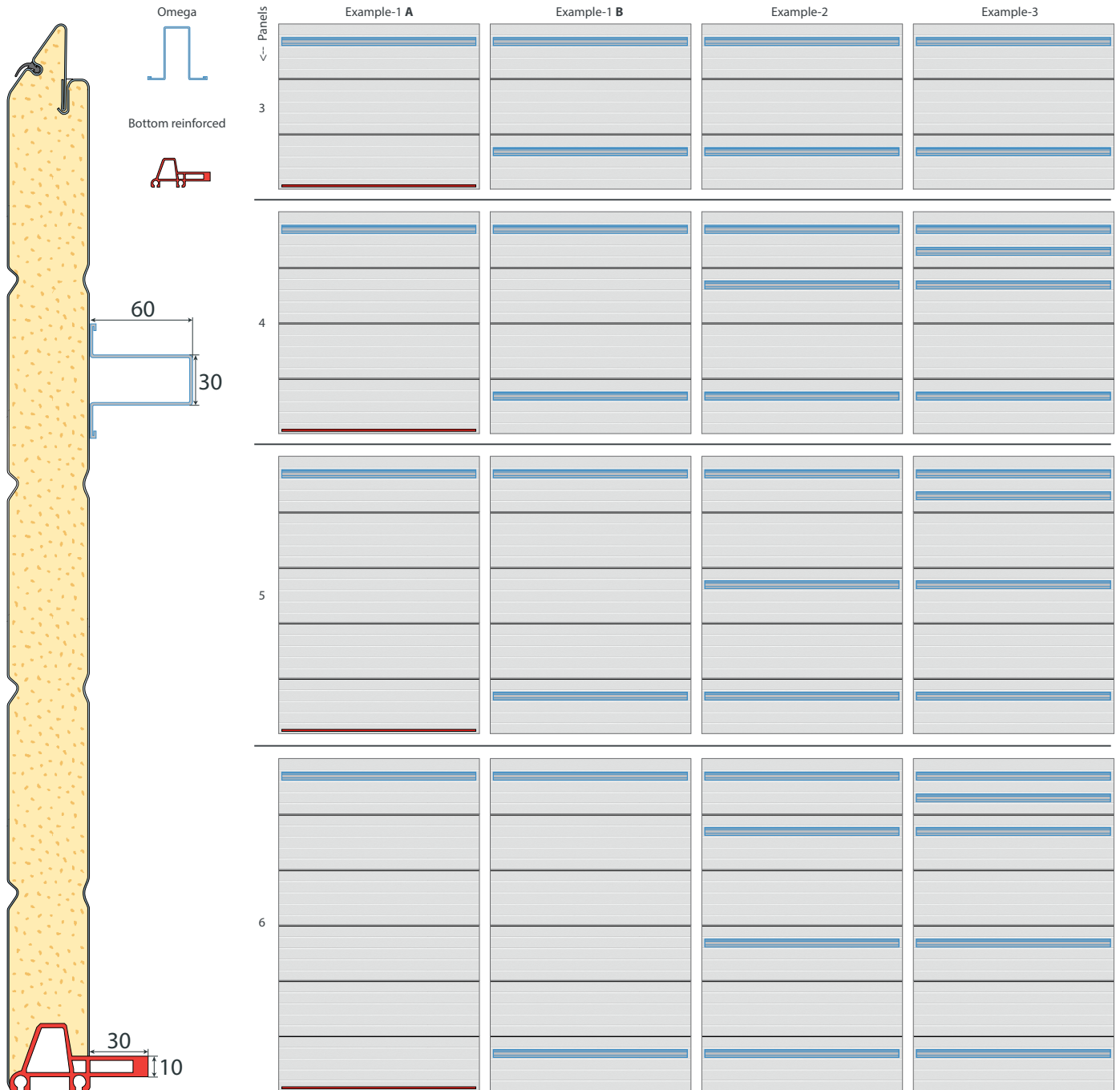

PROFILE FIXING POINTS



DOUBLE INSULATED ACRYLIC (clear / matt / frosted) GLAZING

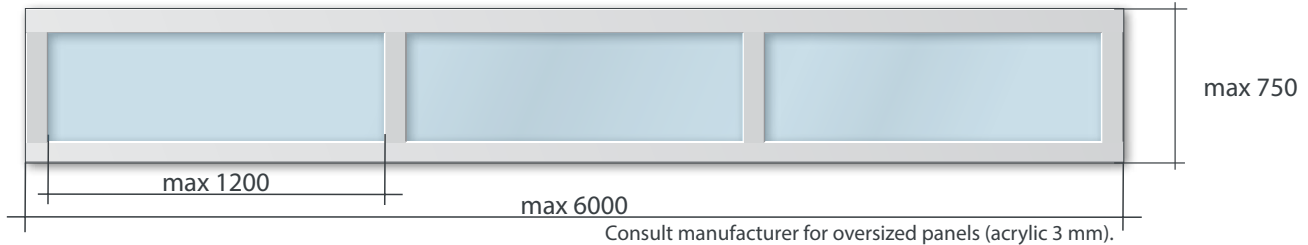

SINGLE / DOUBLE (Safety glass) GLAZING

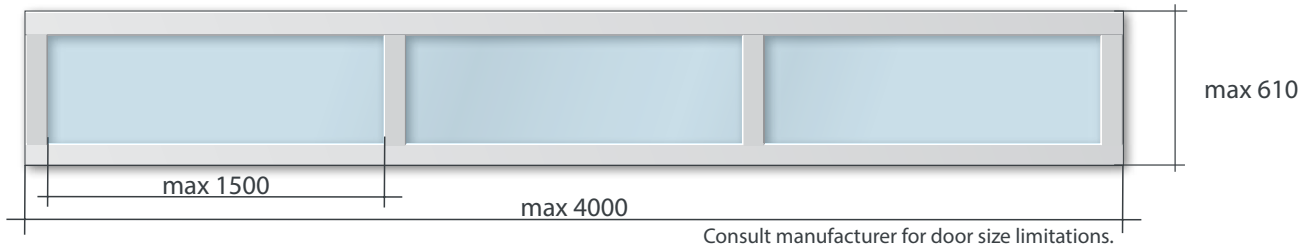

CONTINUOUS GLAZING

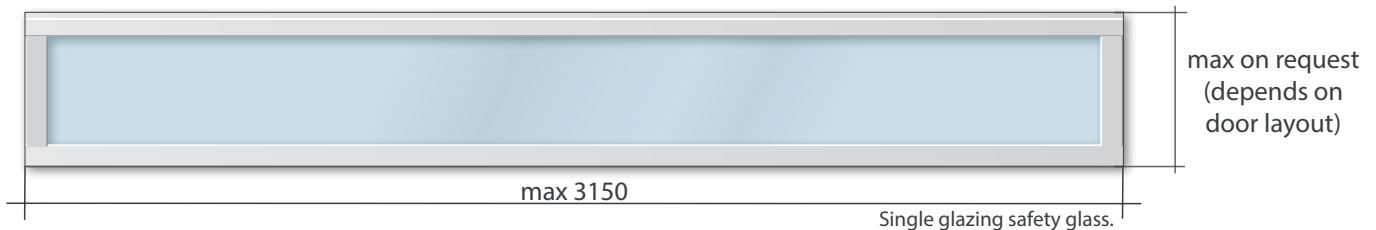
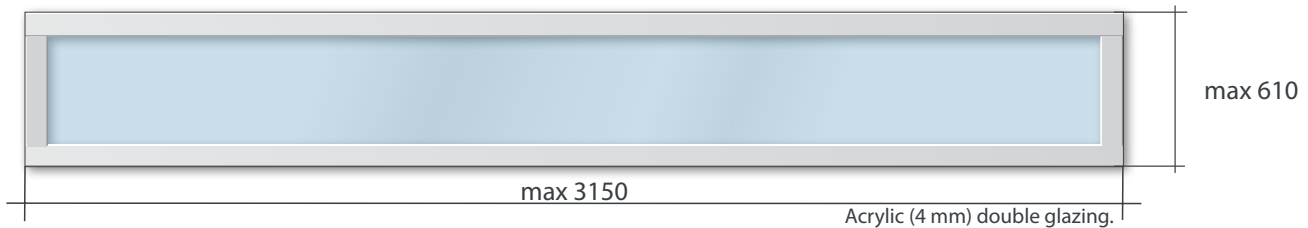

'CROSS' DECORATION

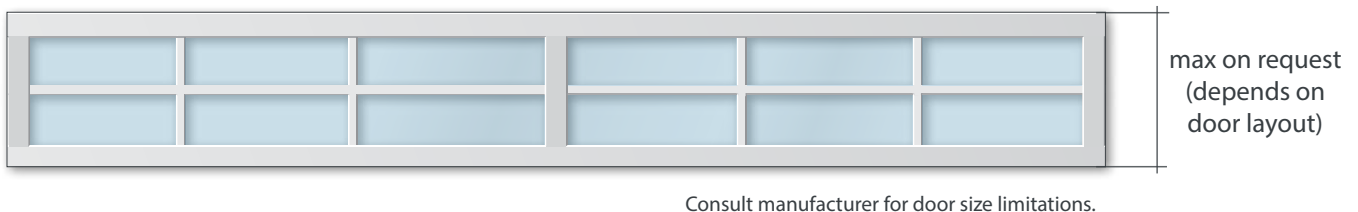

RETRO Z

Z

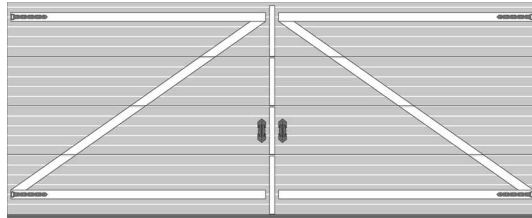
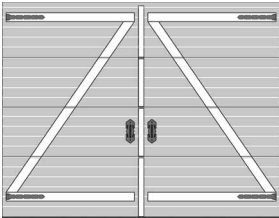

2Z

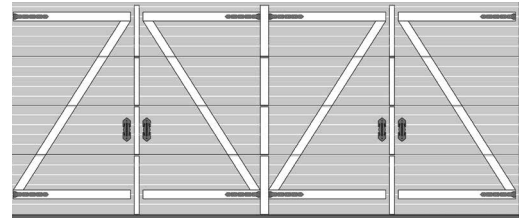

RETRO X

X

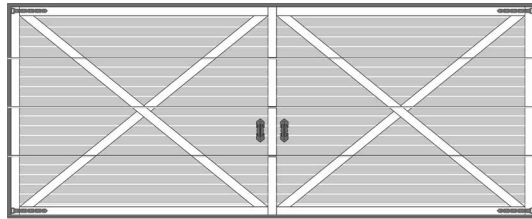
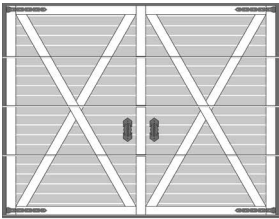

2X

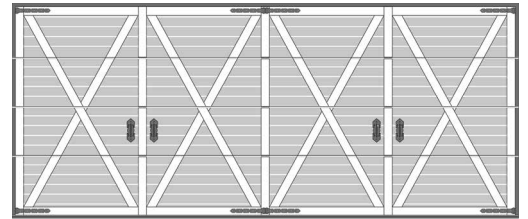

RETRO 4 X

4X

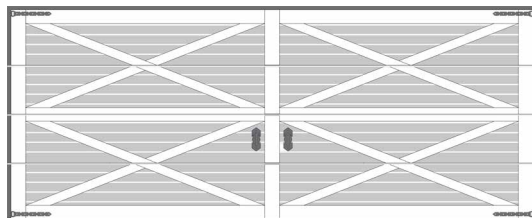
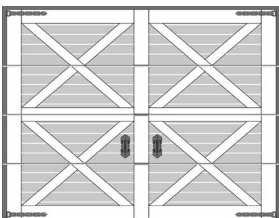

8X

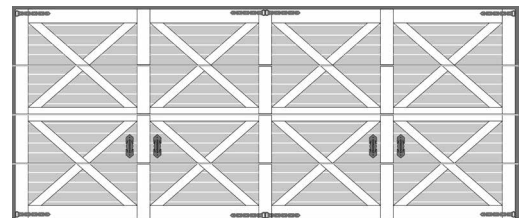

RETRO H

H

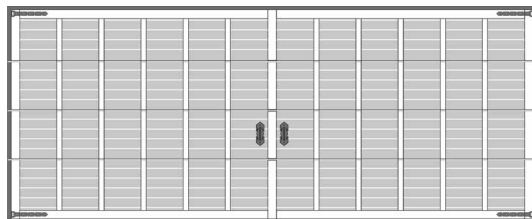
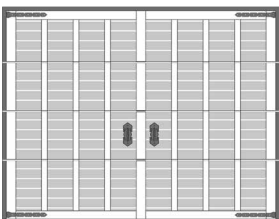

2H

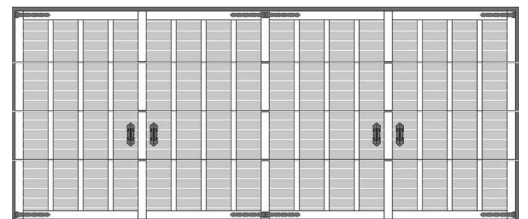

RETRO S

S

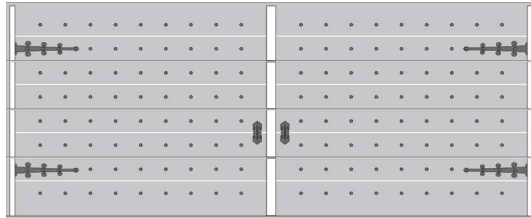
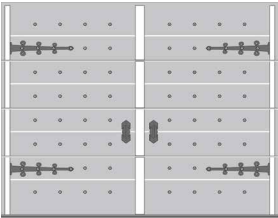

2S

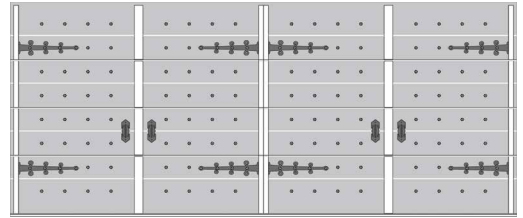

RETRO Z - FV

Z-FV

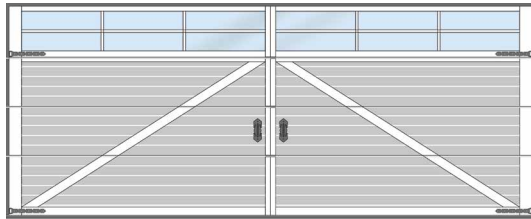
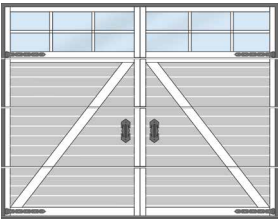

2 Z-FV

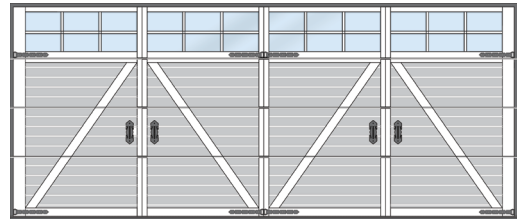

RETRO X - FV

X-FV

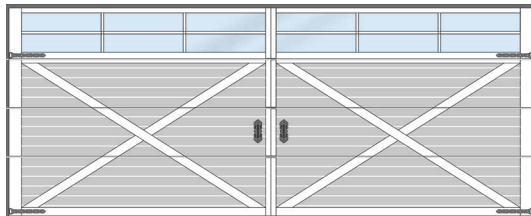
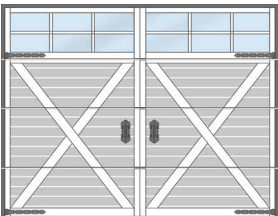

2 X-FV

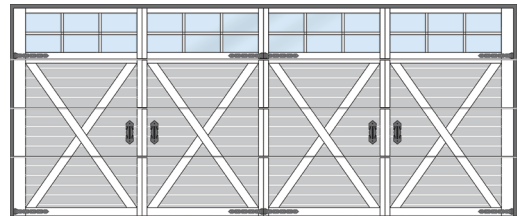

RETRO H - FV

H-FV

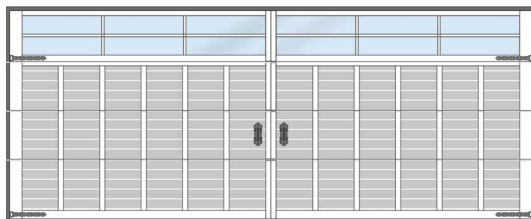

2 H-FV

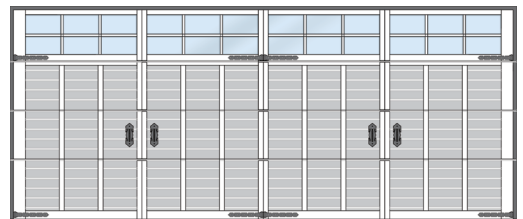

DECOR ELEMENTS



Stainless steel decor elements options

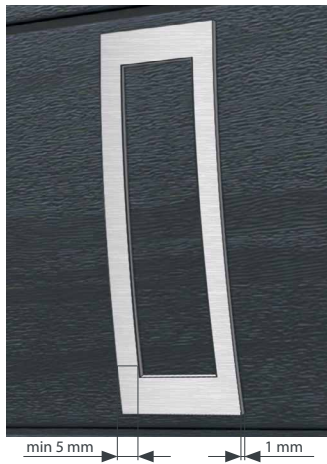

Brushed

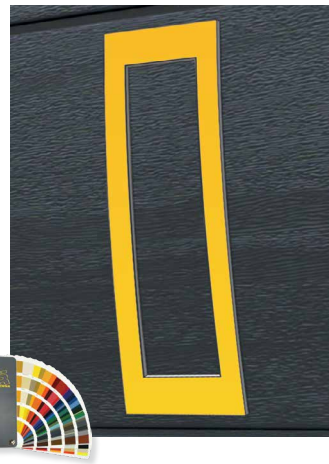

RAL painted



Decor elements combined with windows



RAL painted decor elements & windows



A-01



A-02

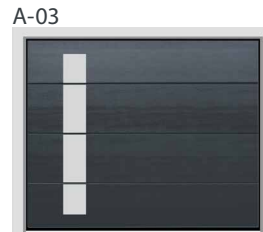

A-03

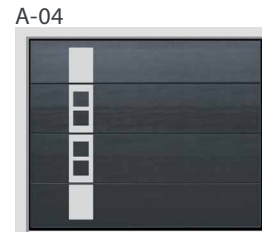

A-04



A-05



A-06



A-07



A-08



A-09



A-10

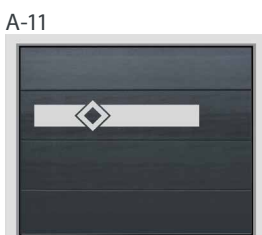

A-11



A-12



A-13



A-14



A-16



A-18

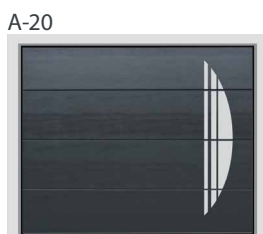

A-20



A-28



AW-01



AW-02



AW-07



AW-13



AW-14



AW-15

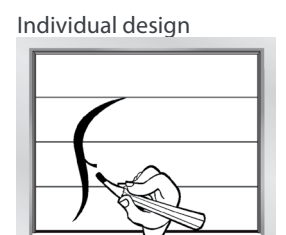

Individual design

WINDOWS

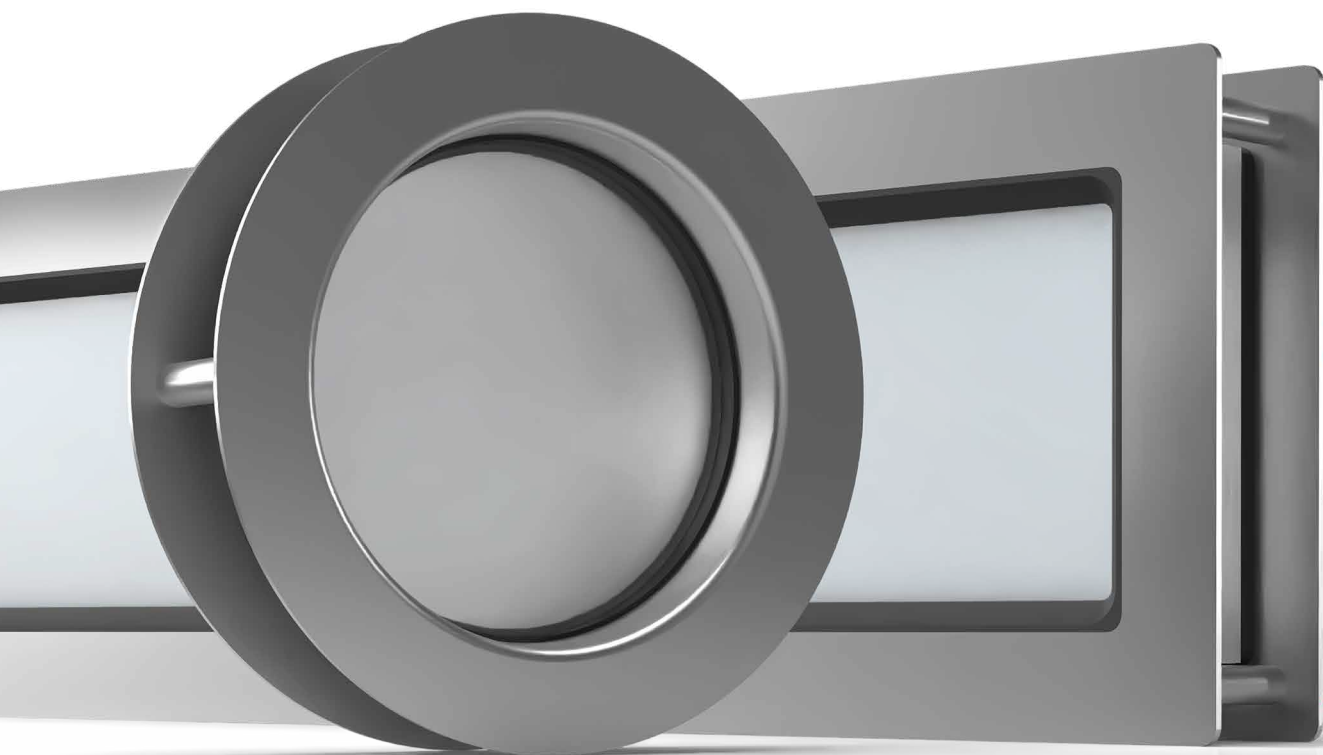

ROUND STAINLESS STEEL WINDOWS (single glazing safety glass)

Painted RAL colours

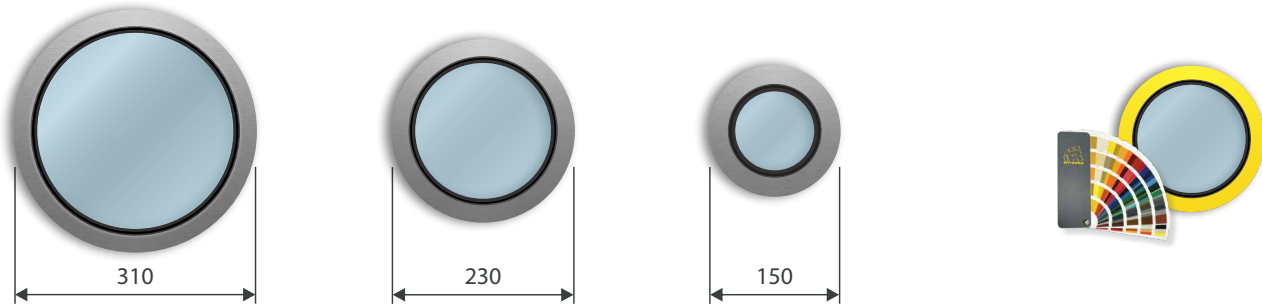

SQUARE STAINLESS STEEL WINDOWS (double glazing safety glass)

Painted RAL colours

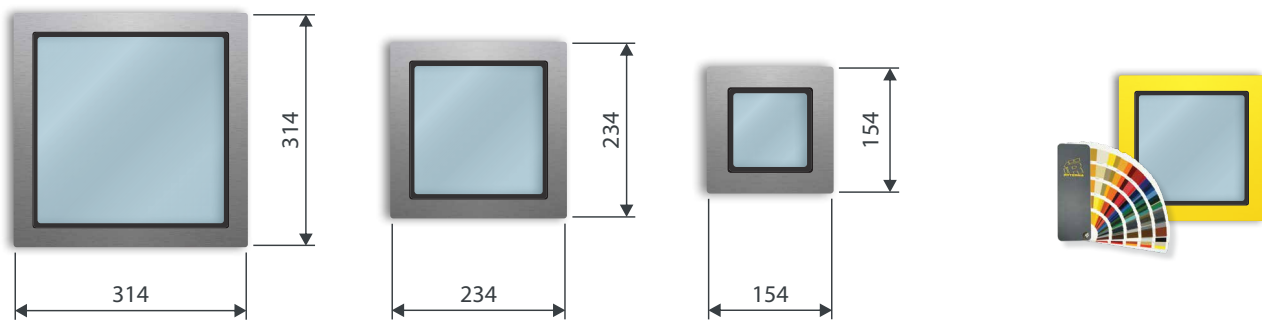

RECTANGULAR STAINLESS STEEL WINDOWS (double glazing safety glass)

Painted RAL colours

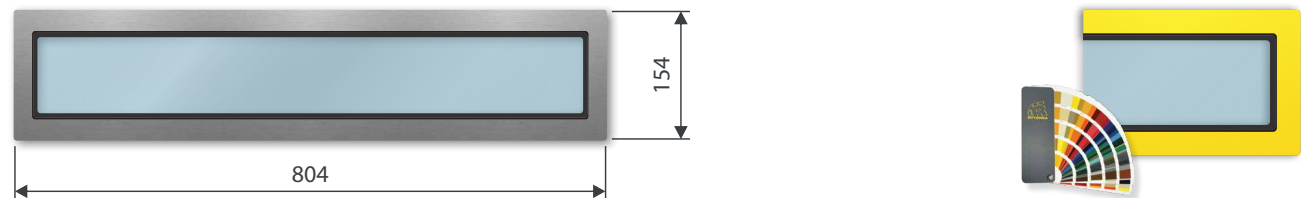

STAINLESS STEEL WINDOWS LOCATION

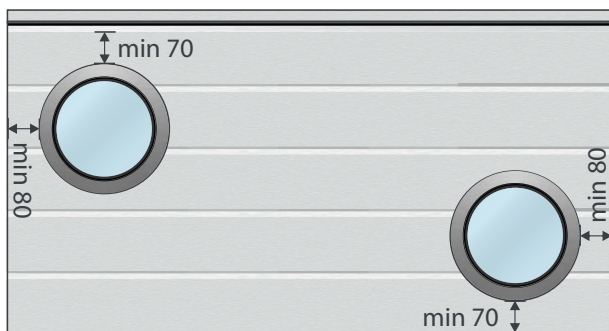

$W \leq 4500$

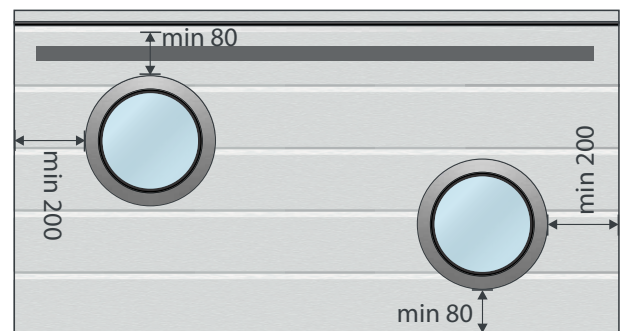

$4501 < W \leq 6000$

TYPE OF GLASS



Clear (glass)



Matt (glass)



Frosted (glass)



Tinted (glass) (grey or brown)

All dimensions are given in millimetres (mm).

STANDARD ACRYLIC DOUBLE GLAZING WINDOWS (standard frame - white/black)

Painted RAL colours



'CROSS' ACRYLIC DOUBLE GLAZING WINDOWS (standard frame - white)

Painted RAL colours

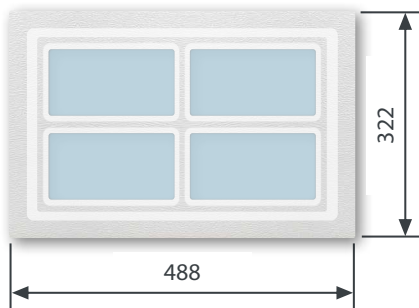

'SUNRISE' ACRYLIC DOUBLE GLAZING WINDOWS (standard frame - white)

Painted RAL colours

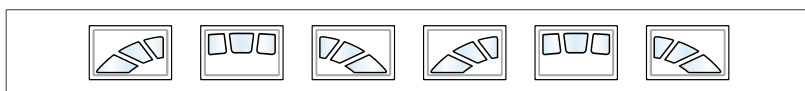
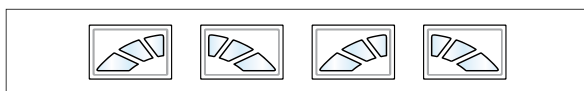
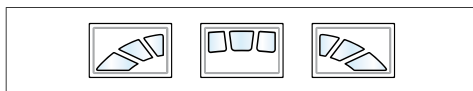
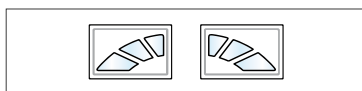
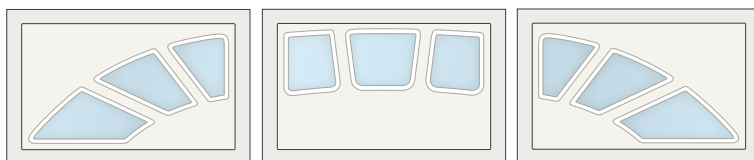

ACRYLIC DOUBLE GLAZING WINDOWS LOCATION

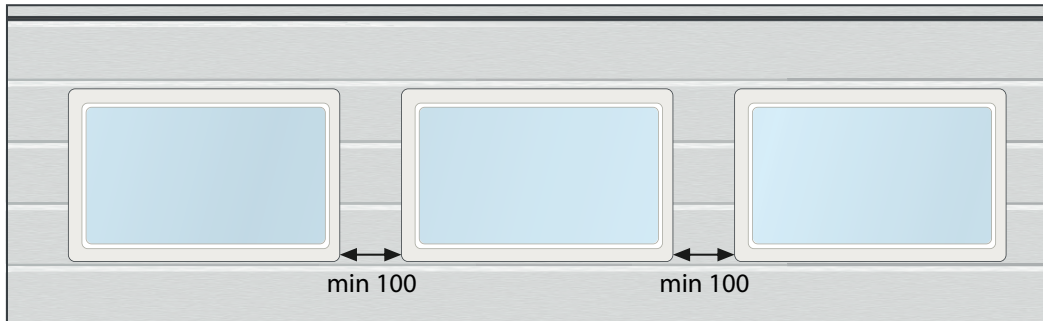

TYPE OF GLASS



Clear (acrylic)



Matt (acrylic)



Frosted (acrylic)



Tinted (acrylic) (grey or brown)

WICKET DOORS



WICKET DOOR CRITICAL DIMENSIONS

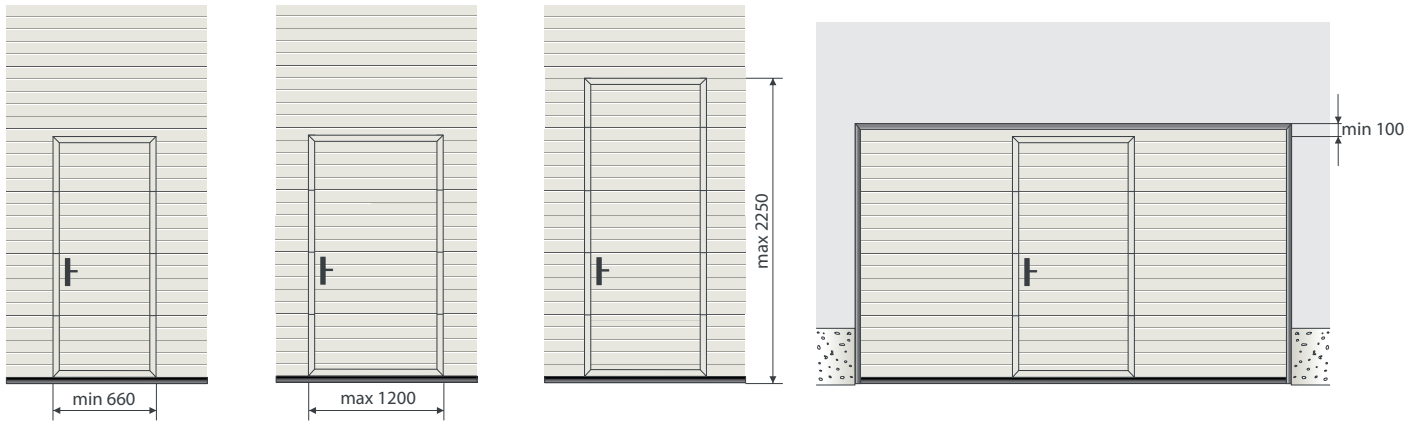

WICKET DOOR WITH STANDARD THRESHOLD

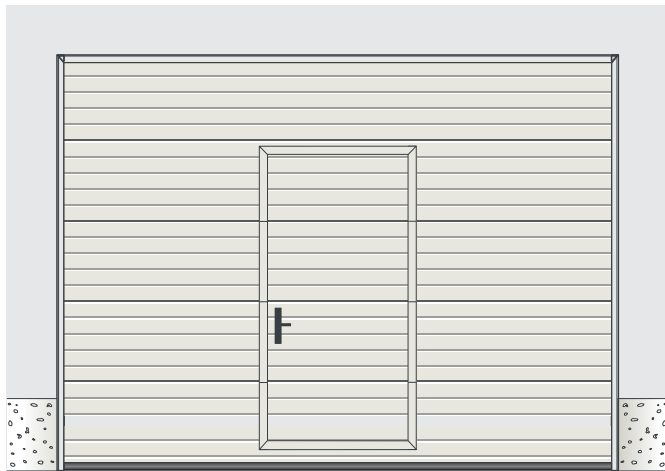

WICKET DOOR WITH LOW THRESHOLD

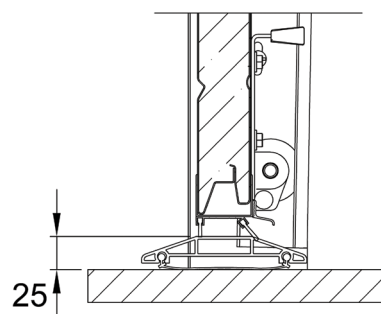
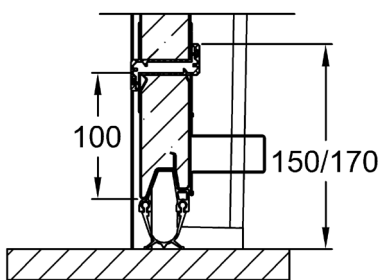
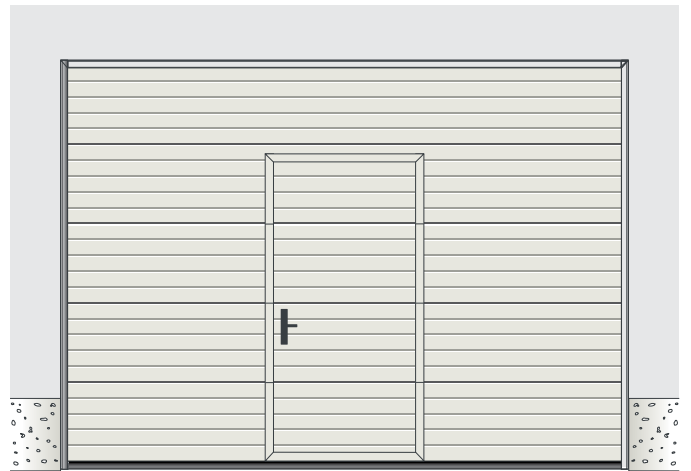

HANDLE OPTIONS



Black handle
22050



White handle
22050



Silver handle
22050



Fixed knob (optional)
22046

Black handle - on wood image and painted doors.
White handle - on white doors.
Silver handle - on silver doors and by request.

STANDARD THRESHOLD

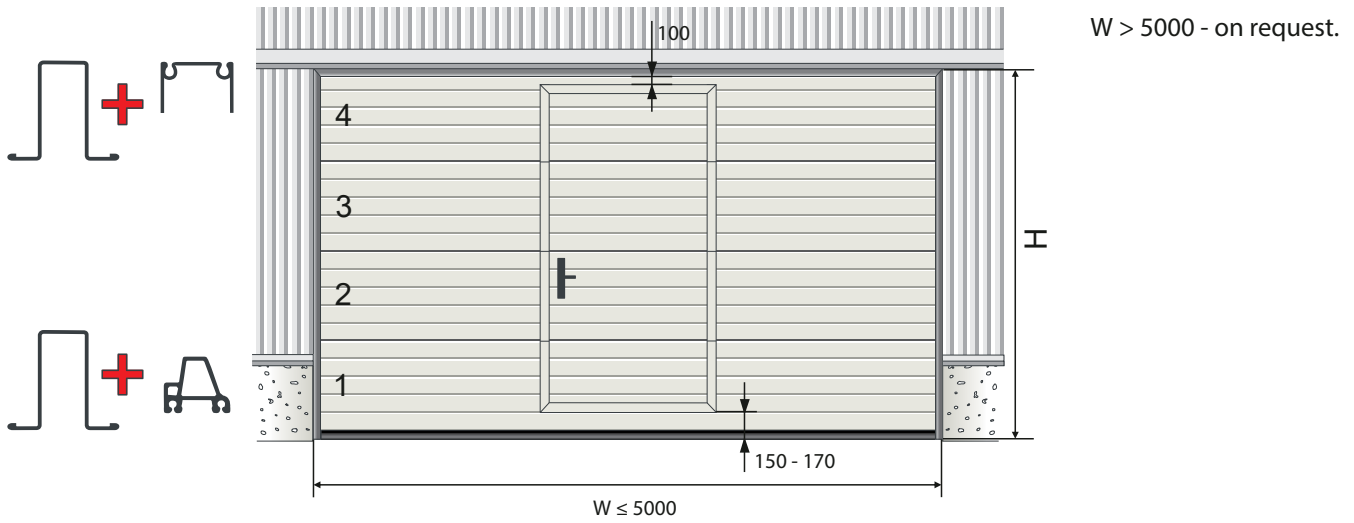

LOW THRESHOLD

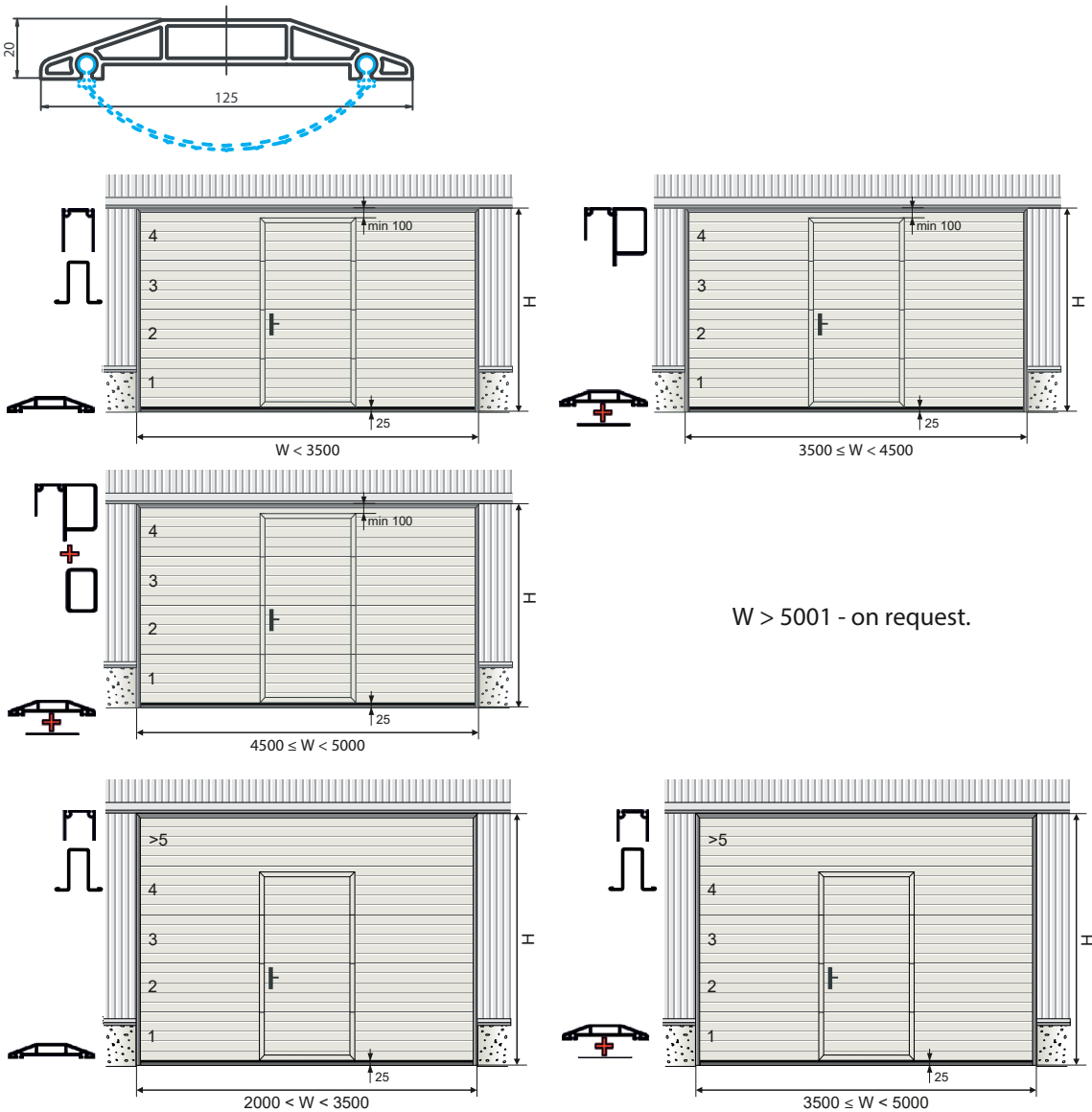

EXTERNAL VIEW

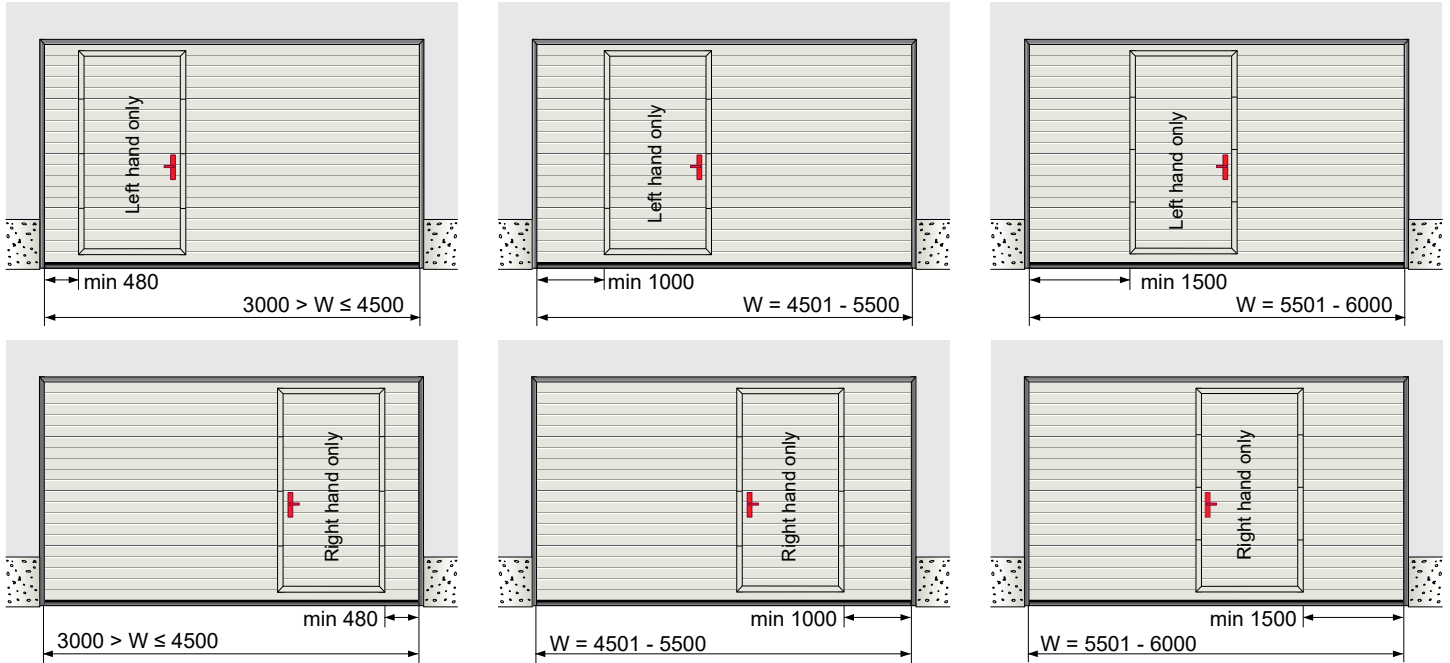

Handle side (L/R) may be chosen when the wicket door is centred.

Wicket door with higher threshold.

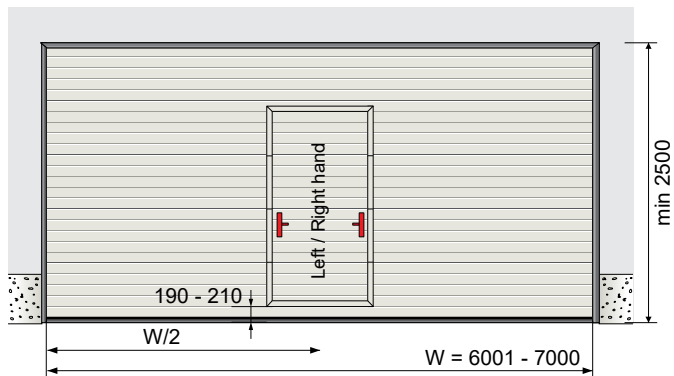
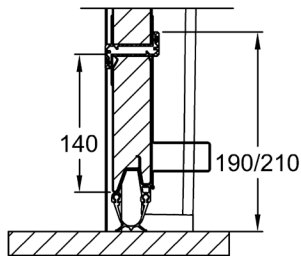

GEORGIAN (CASSETTE) PANELS

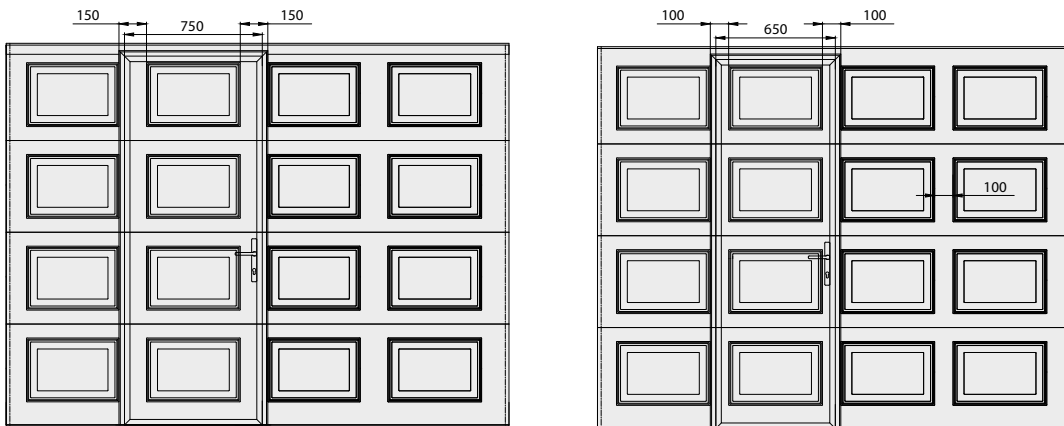

For doors with Georgian (Cassette) panels and wicket door consult manufacturer.

SIDE HINGED DOORS



Side hinged doors SH1

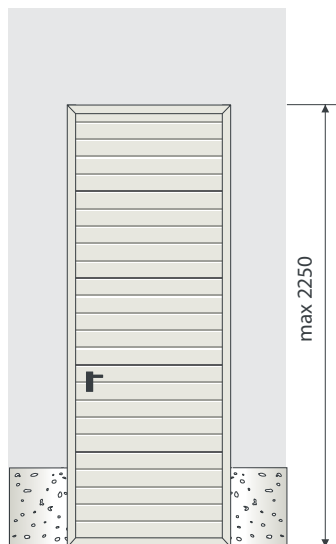
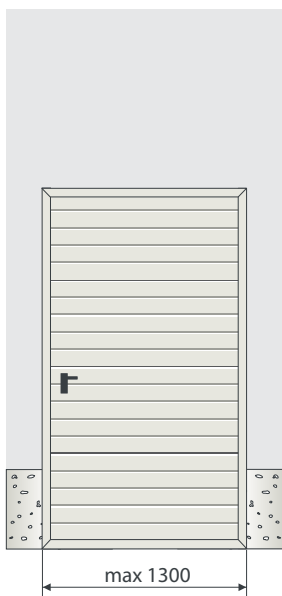
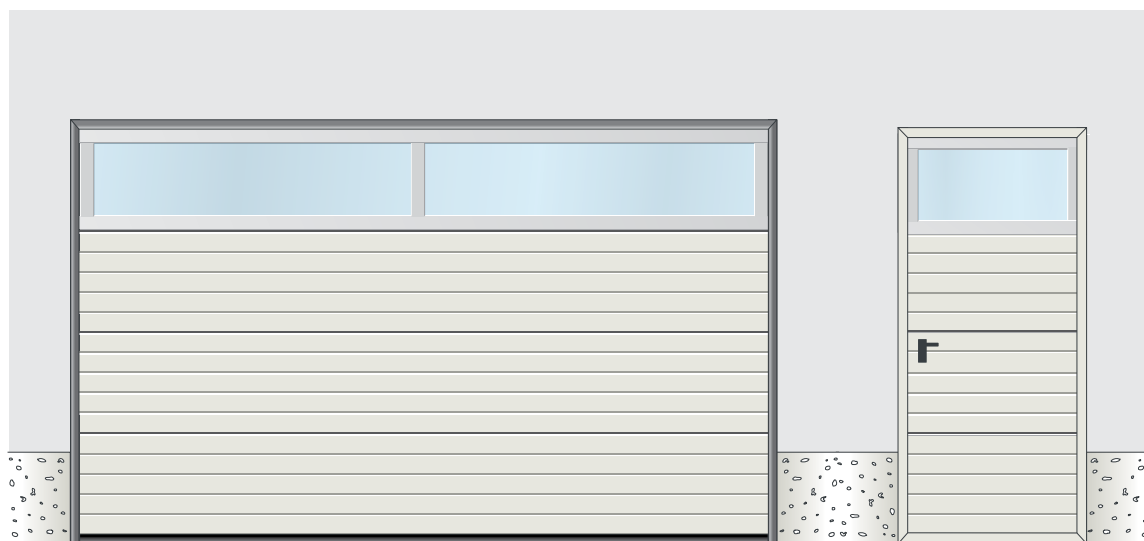
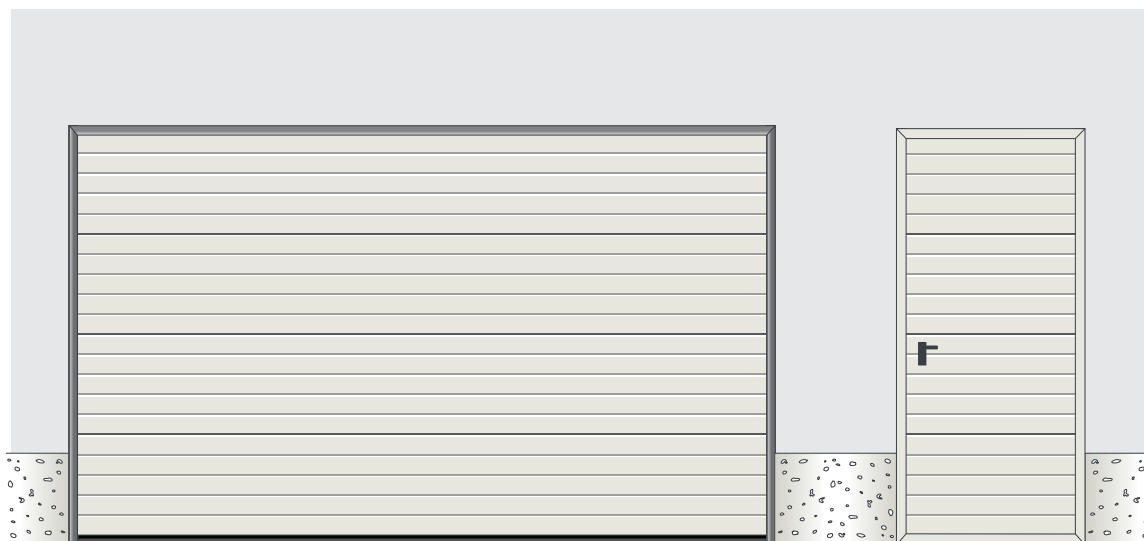

All dimensions are given in millimetres (mm).

SIDE DOORS FITTING AND OPENING OPTIONS

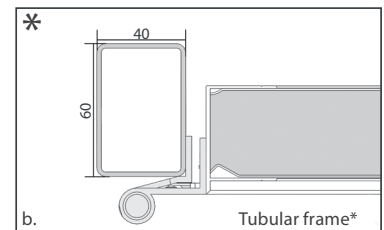
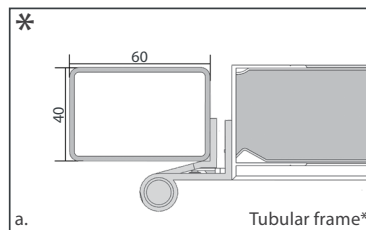
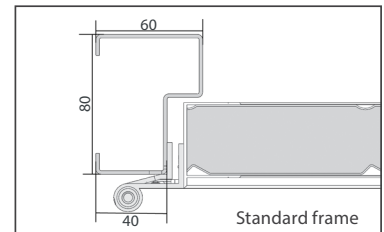
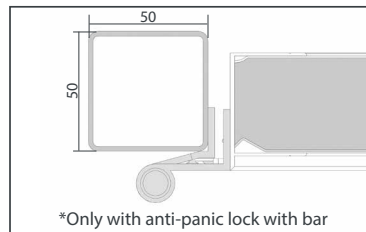
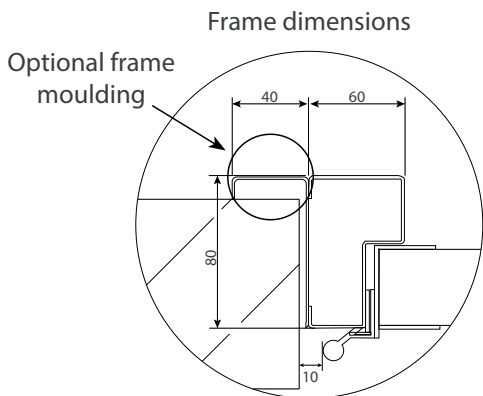
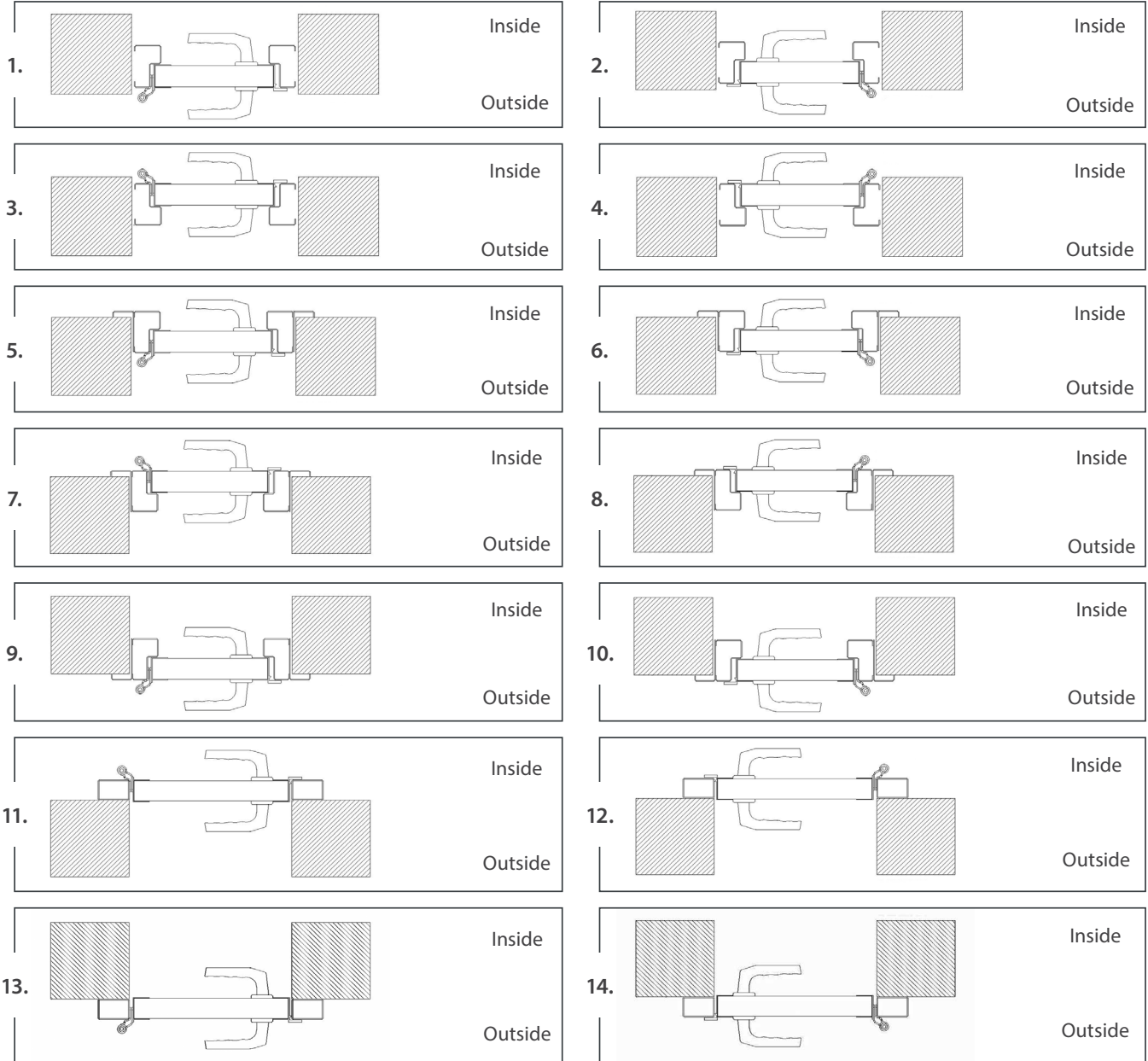

*With threshold S5 side door frame from tube 80x40.



Tolerance of 10 in width and height will be deducted from structural opening sizes given.

SIDE DOORS THRESHOLD TYPES

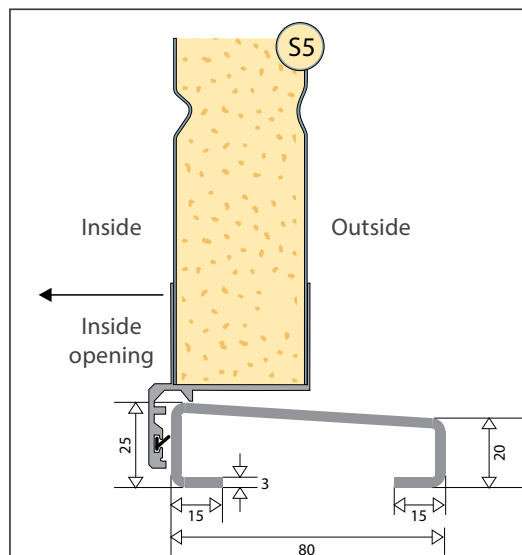
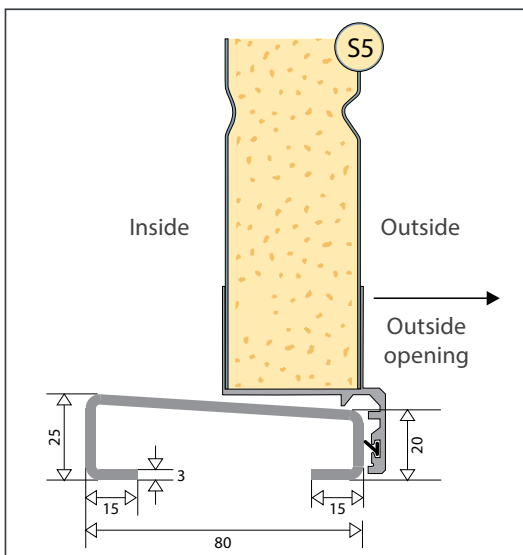
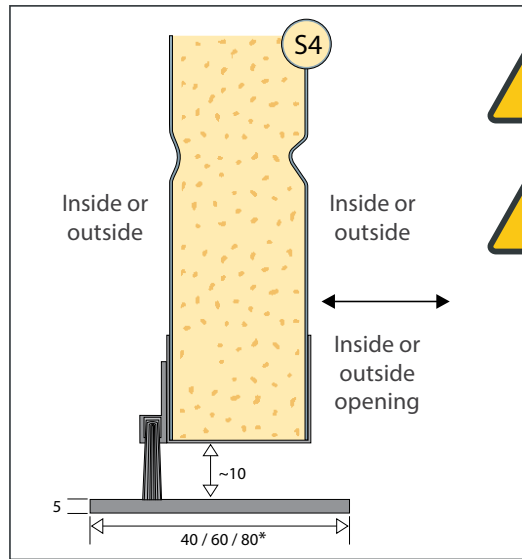
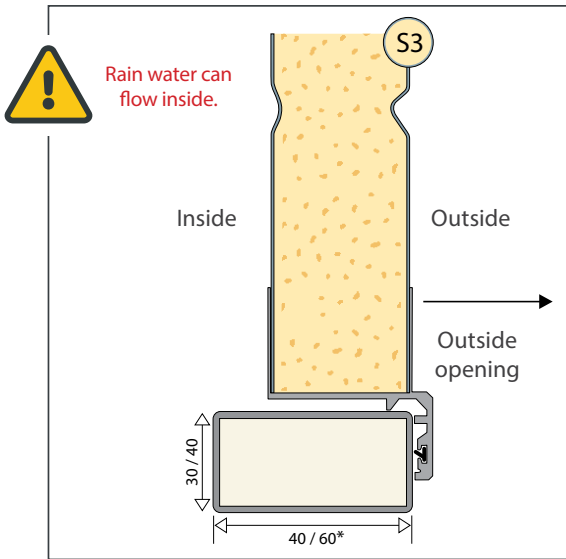
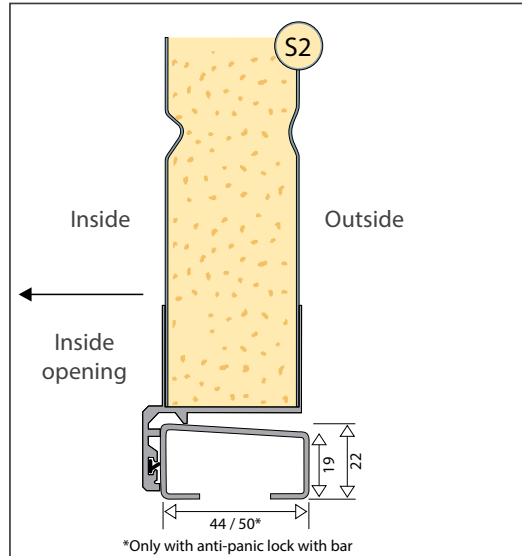
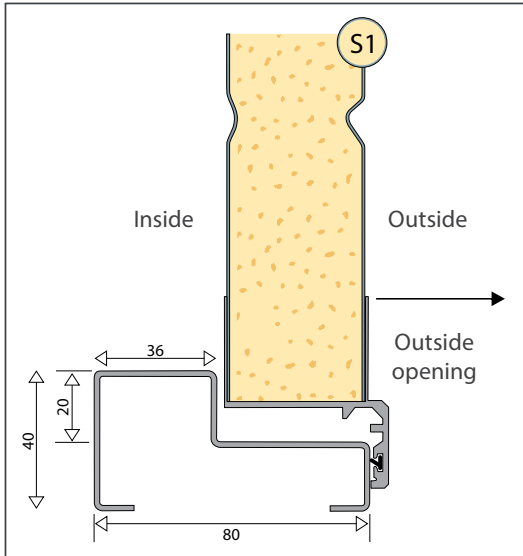

*Depends on door frame option
All dimensions are given in millimetres (mm).

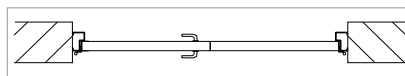
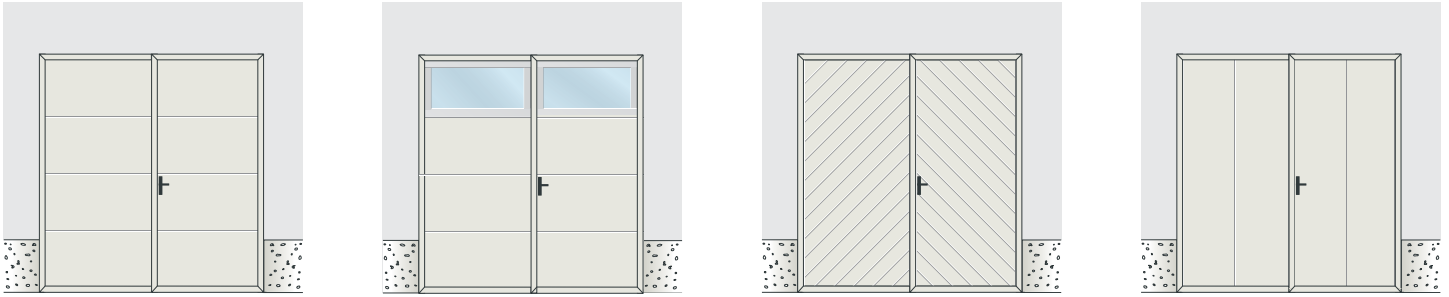

Two leaf doors are recommended when the opening is wider than 1300.

Optional frame moulding

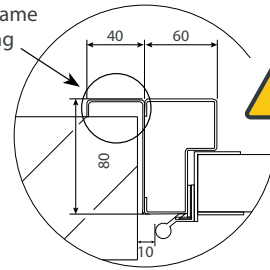

Frame dimensions

Tolerance of 10 in width and height will be deducted from structural opening sizes given.

DOUBLE SIDE DOOR CRITICAL DIMENSIONS

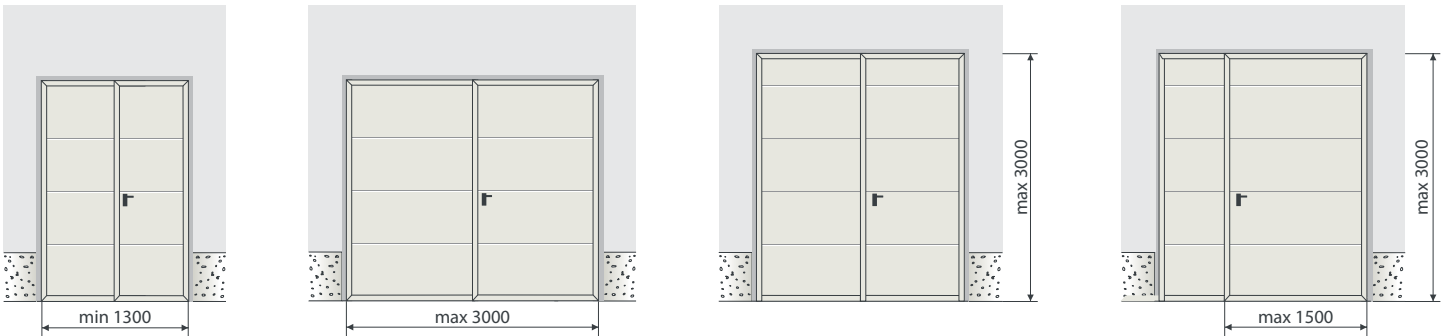

STANDARD HANDLES



Black handle
22050



White handle
22050



Silver handle
22050

Black handle - on wood image and painted doors.
White handle - on white doors.
Silver handle - on silver doors and by request.

OPTIONAL HANDLES



Fixed knob
22046



Stainless steel
HLS 02



Stainless steel
HLS 03



Stainless steel
HLS 04



Stainless steel
HLS 05



Stainless steel
HLS 06



Stainless steel
HLS 12



Stainless steel
anti-panic handles
ASSA Modular
565
(Only with full lock 22035)



Chrome plated
ASSA Modular
565

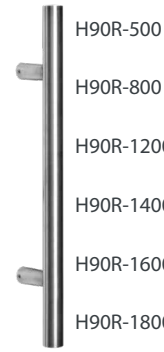

H90R
Ø 30 mm 90°

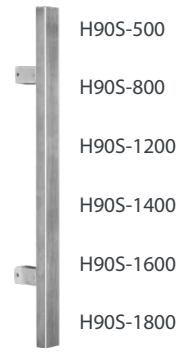

H90S
30x20 mm 90°

SH2 OPENING AND HANDLING OPTIONS

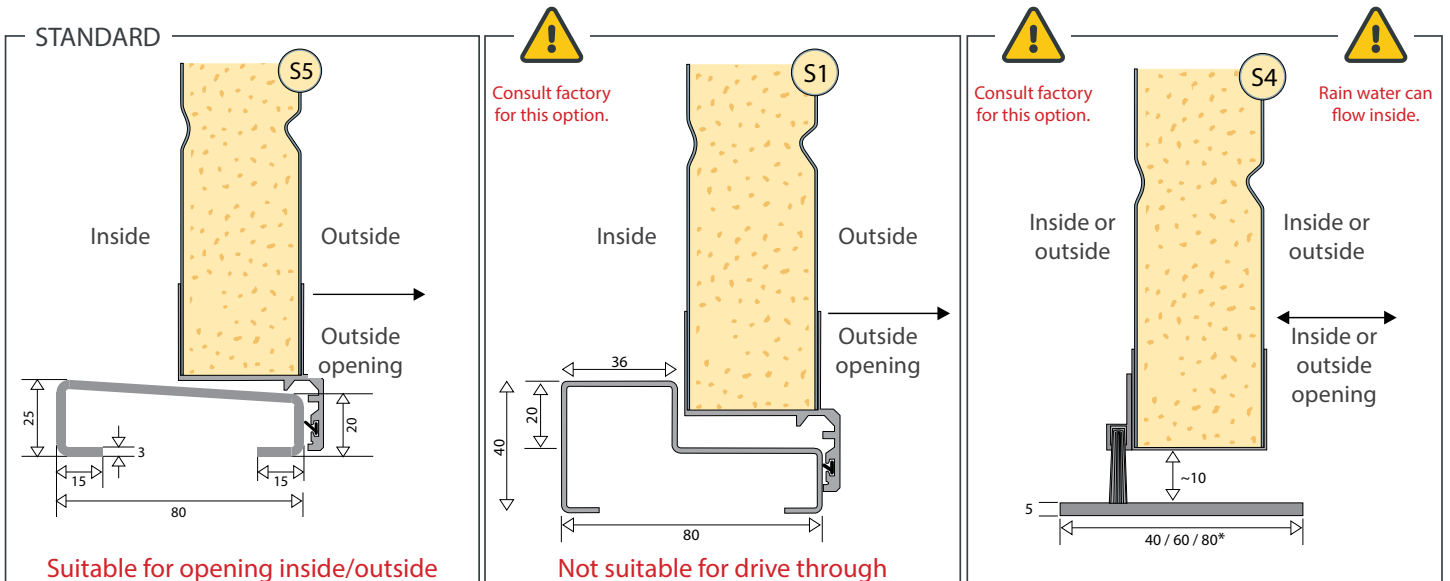
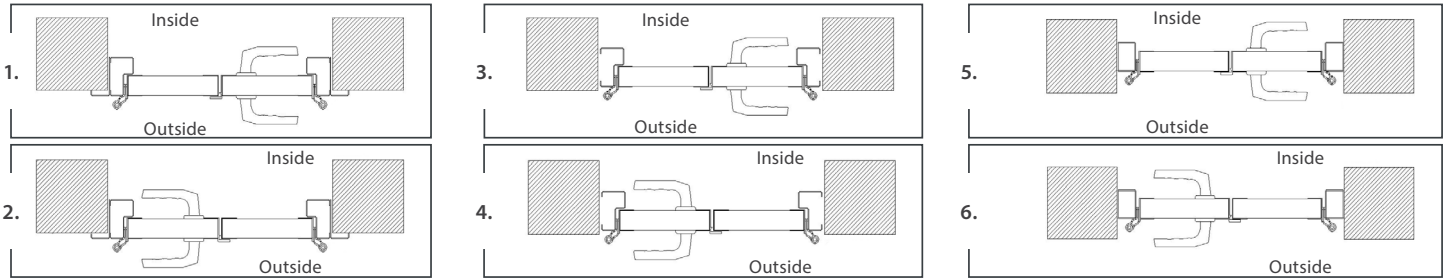

*Depends on door frame option

LOCKING OPTIONS AND DOOR STAYS

Espagnolette lock (optional).

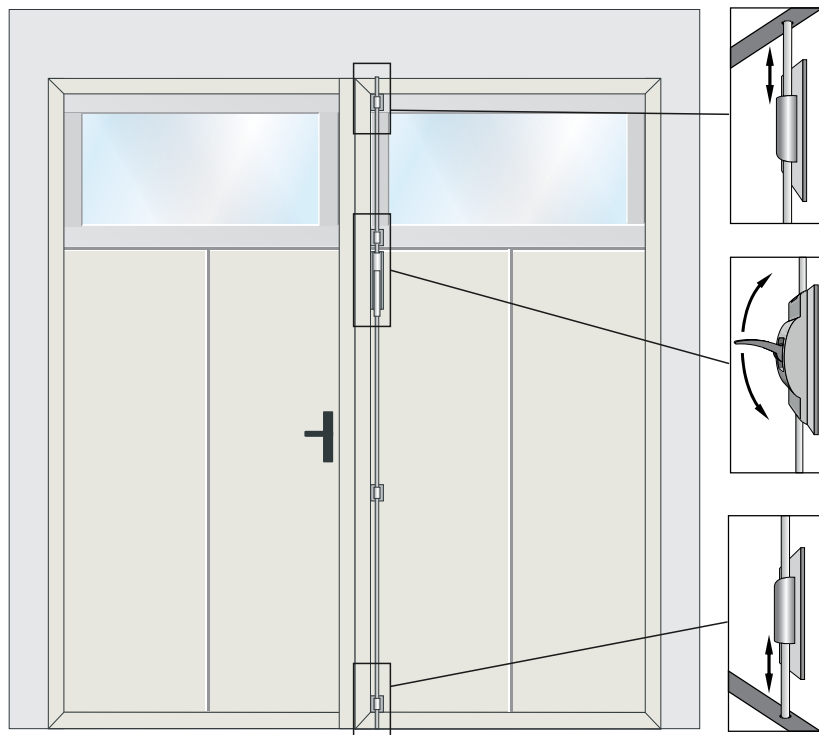

Door stays (pr). Door leaf 700<. Opening 90° / 110° (optional).



Locking of the fixed door leaf. Top / bottom (standard).

Shoot bolt for leaf fixation (optional).



SH2 THERMO



Aluminium insulated doors SH2 THERMO



SH2T P - with 40 mm slick design panel filling

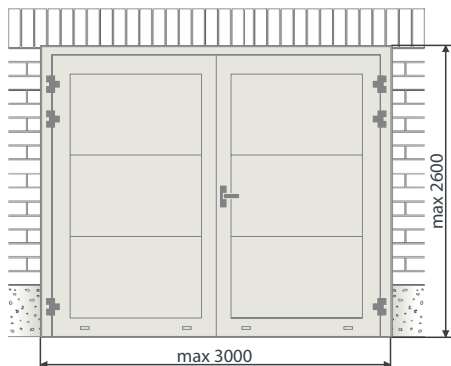

Standard colours

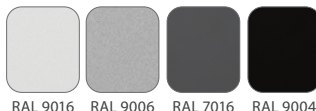

RAL 9016 RAL 9006 RAL 7016 RAL 9004

Painted RAL colours & Slick Plus panels



- Door frame size up to: 3000x2600
- Hinges and handle (standard colours: white, black, silver)
- 1-point lock
- Integrated shoot bolts
- Door stays

Door model SH2T P filling inside, Stucco embossed RAL 9002.

Opens only to the outside.
Not suitable for drive through.

SH2T P+FV – with 40 mm slick design panel filling + FV panel

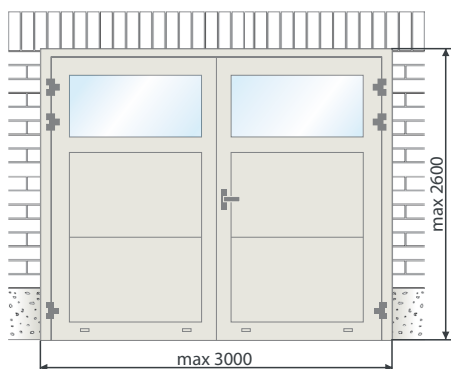

Standard colours



RAL 9016 RAL 9006 RAL 7016 RAL 9004

Painted RAL colours & Slick Plus panels



- Door frame size up to: 3000x2600
- Double clear safety glazing/matt (max height 520)
- Hinges and handle (standard colours: white, black, silver)
- 1-point lock
- Integrated shoot bolts
- Door stays

Door model SH2T P+FV filling inside, Stucco embossed RAL 9002.

Opens only to the outside.
Not suitable for drive through.

SH2T S+FV – with 40 mm aluminium sandwich filling + FV panel

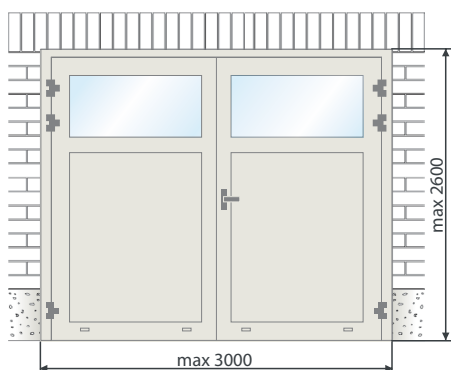

Standard colours



RAL 9016 RAL 9006 RAL 7016 RAL 9004

Painted RAL colours & Slick Plus panels



- Door frame size up to: 3000x2600
- Double clear safety glazing/matt (max height 520)
- Hinges and handle (standard colours: white, black, silver)
- 1-point lock
- Integrated shoot bolts
- Door stays

Door model SH2T S+FV sandwich filling inside Smooth, same as door colour.

Opens only to the outside.
Not suitable for drive through.

OPTIONS



1 Integrated espagnolette



2 'Stabilus' gas door stays



3 Hinges
(standard colours: white, black, silver)
K80105448

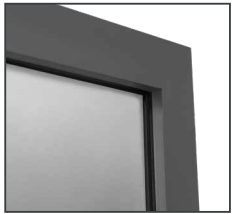

4 Double clear safety glazing / matt



5 Handle
(standard colours: white, black, silver)
K19241108



6 Escutcheon
(standard colours: white, black, silver)
K19241138



7 Door stays
22061



8 Integrated shoot bolts
K80009618



MORE OPTIONS

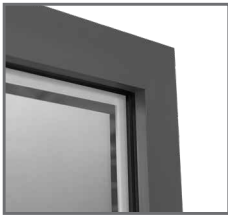

Custom sand blasted glazing



Custom colour hinges and handle



Fixed knob with escutcheon
(colours: black, white, silver)



3-point lock for door frame
2390–2600 height
(handle min 1200 from floor)
3-point lock for door frame
2060–2389 height (integrated espagnolette included)
(handle min 1050 from floor)

Look for prices in the **GARAGE & INDUSTRIAL DOORS PRICELIST**

FRAME PROFILE CROSS-CUT VIEW

